



KENNY'S

Special

COLLECTION



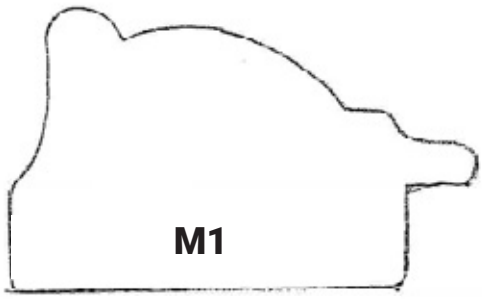

M1

$1\frac{1}{2}'' \times 2\frac{3}{8}''$

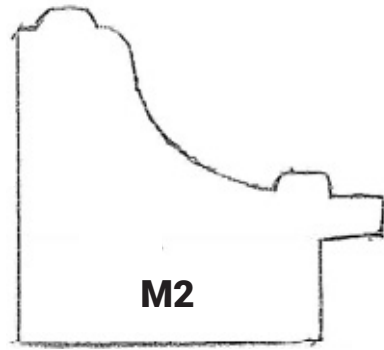

M2

$1\frac{3}{4}'' \times 1\frac{7}{8}''$

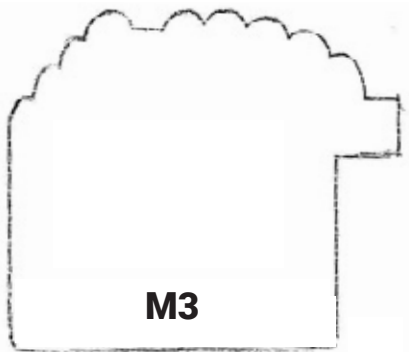

M3

$1\frac{3}{4}'' \times 2''$

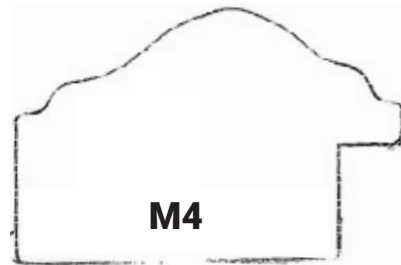

M4

$1\frac{1}{4}'' \times 2''$

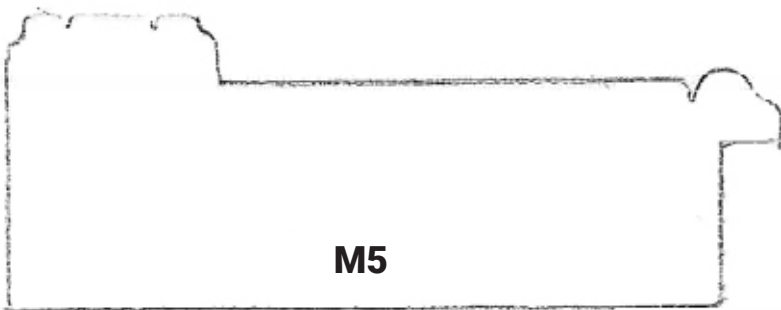

M5

$1\frac{1}{2}'' \times 4''$



M6

$1'' \times 2\frac{1}{4}''$

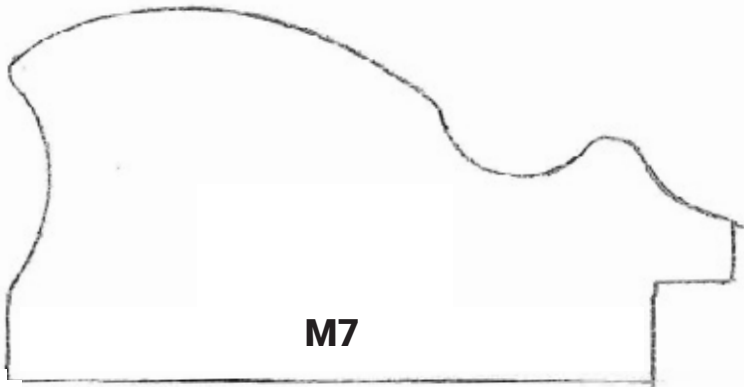

M7

1 ⁷/₈" x 3 ³/₄"



M8

1 ³/₄" x 2 ⁷/₈"

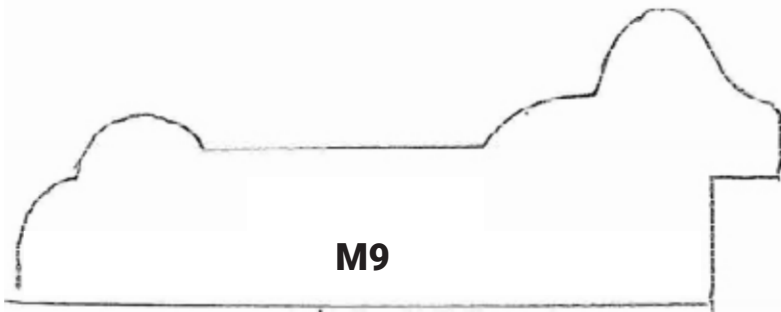

M9

1 ¹/₂" x 4"

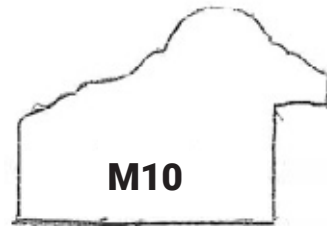

M10

1 ¹/₈" x 1 ⁵/₈"

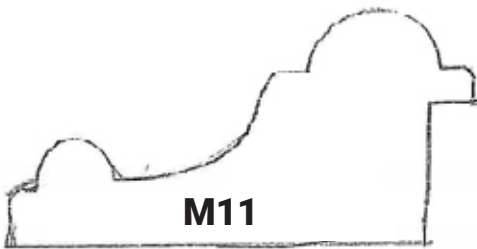

M11

1 ¹/₄" x 2 ¹/₄"

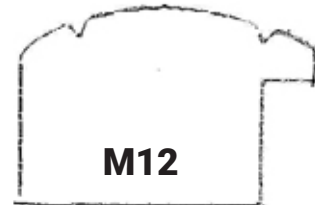

M12

1" x 1 ¹/₂"



$\frac{3}{4}'' \times 3\frac{1}{4}''$



$1\frac{1}{8}'' \times 3\frac{7}{8}''$

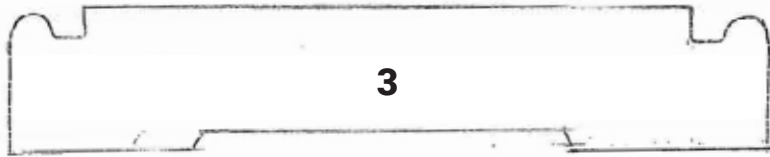

$\frac{3}{4}'' \times 4''$



$\frac{3}{4}'' \times 3''$

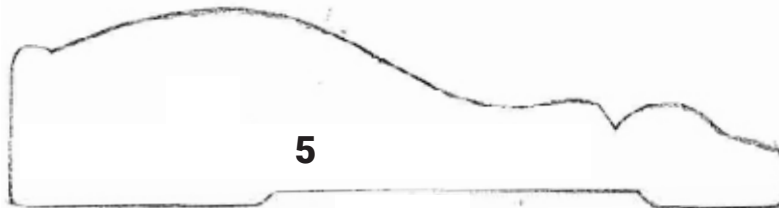

$1'' \times 4''$

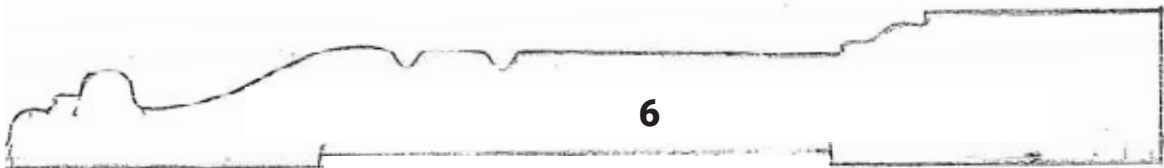

$\frac{3}{4}'' \times 6''$

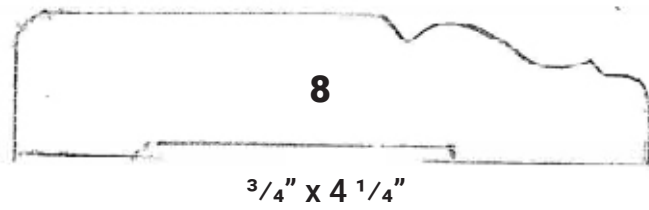
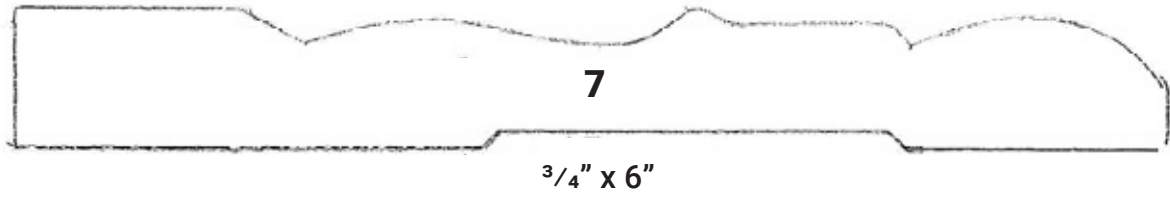

Base same but longer - $\frac{5}{8}''$ tack

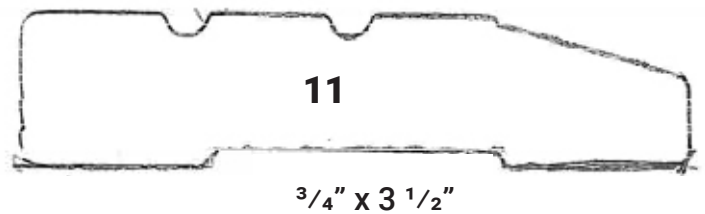
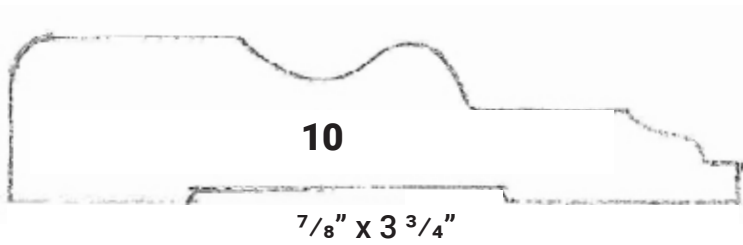
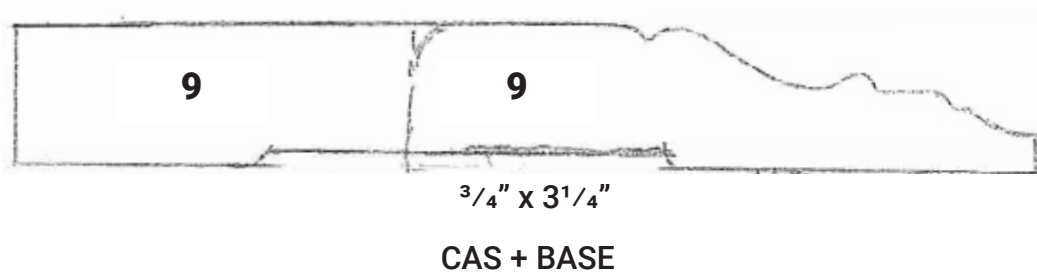



**BASE
11**

$\frac{5}{8}$ " x 6"



12

$\frac{3}{4}$ " x 3 $\frac{1}{2}$ "



13

$\frac{3}{4}$ " x 3"

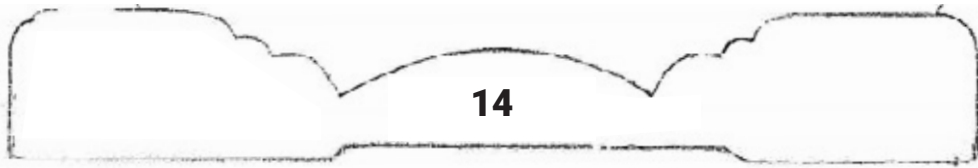

14

$\frac{3}{4}$ " x 5"

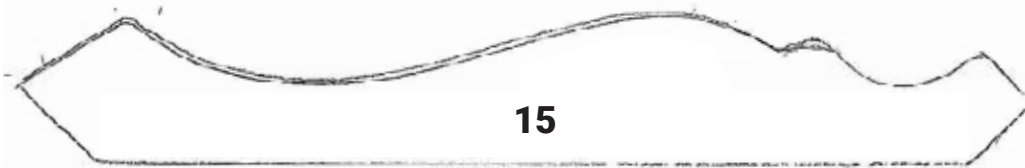

15

$\frac{3}{4}$ " x 5 $\frac{1}{4}$ "



16

$\frac{3}{4}$ " x 6"

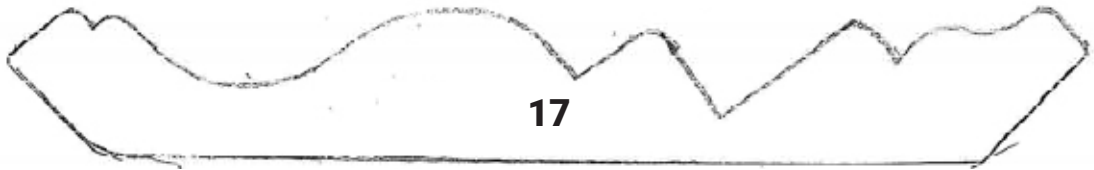

17

$\frac{3}{4}'' \times 5 \frac{1}{8}''$



18

$1 \frac{3}{16}'' \times 5 \frac{7}{8}''$



19

$3 \frac{1}{4}'' \times 4 \frac{1}{4}''$

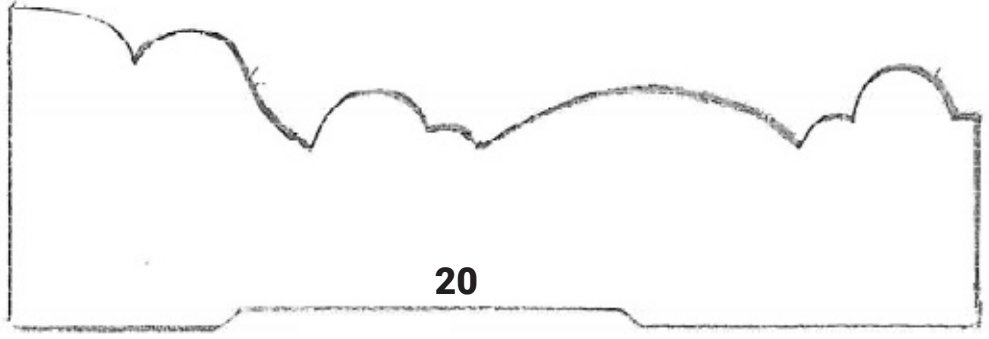

20

$1 \frac{5}{8}'' \times 5''$



21

$\frac{3}{4}'' \times 4''$

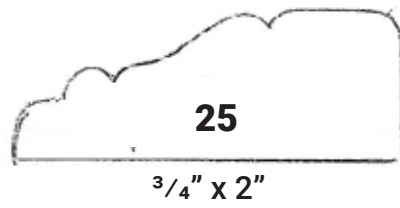
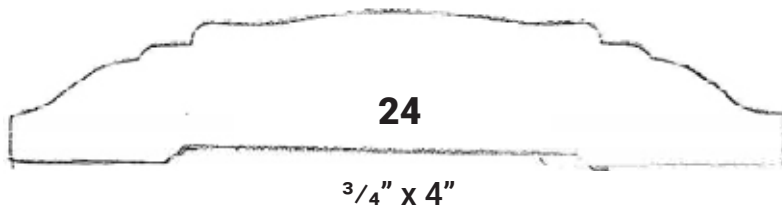
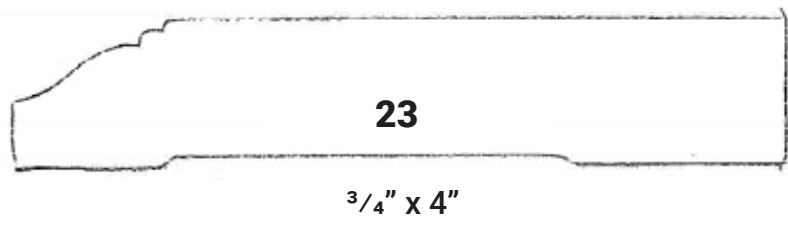
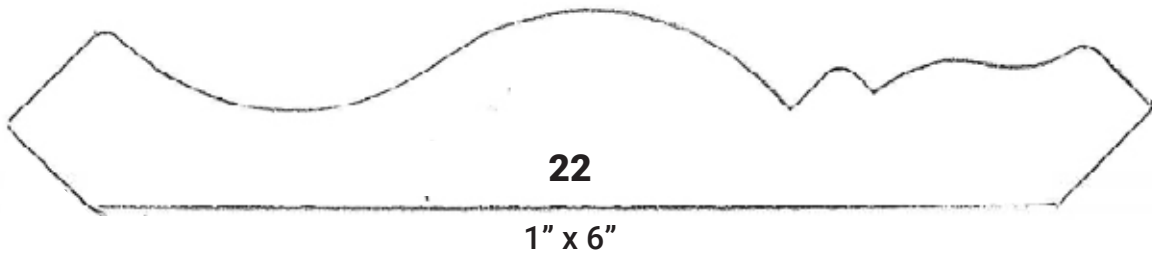

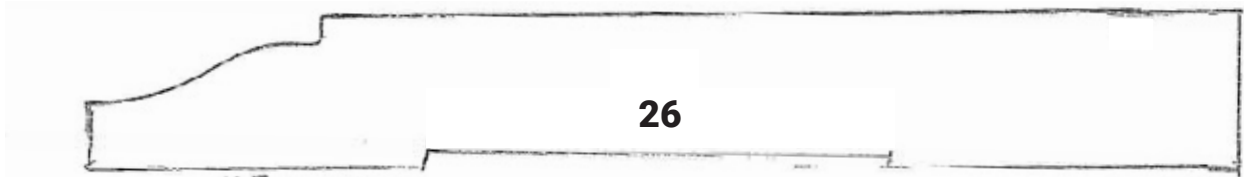

26
 $1 \frac{3}{16}'' \times 6''$



27
 $\frac{3}{4}'' \times 6''$

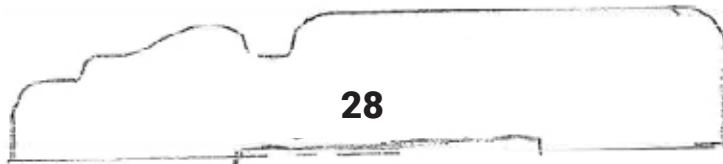

28
 $\frac{3}{4}'' \times 3 \frac{3}{4}''$



29
 $\frac{3}{4}'' \times 5 \frac{1}{8}''$

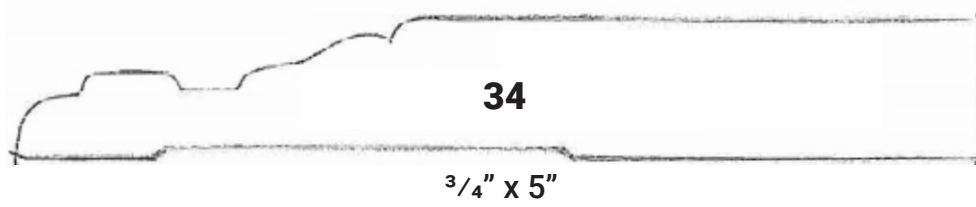
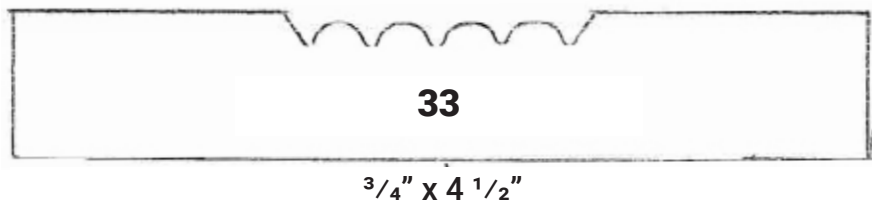
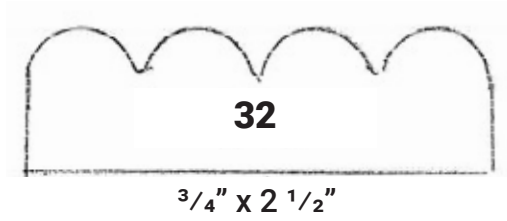
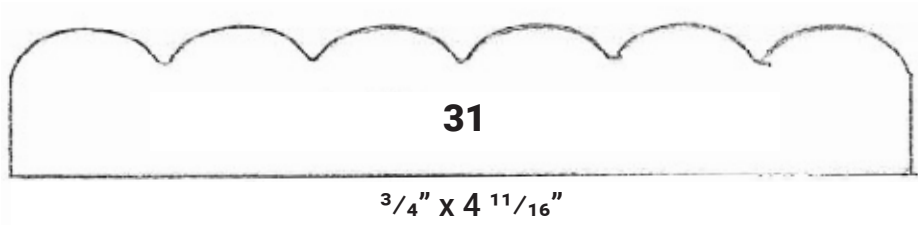
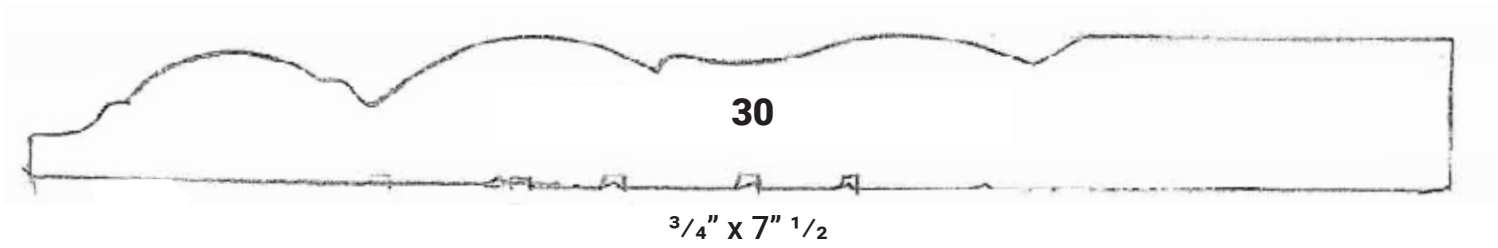



$3/4'' \times 4 3/4''$



$3/4'' \times 7 1/4''$

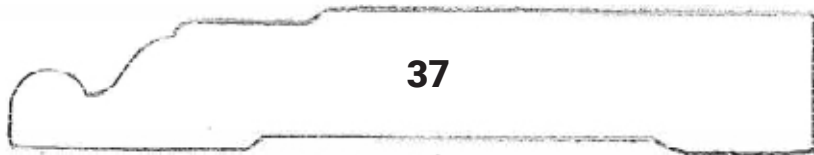

$3/4'' \times 4 1/4''$

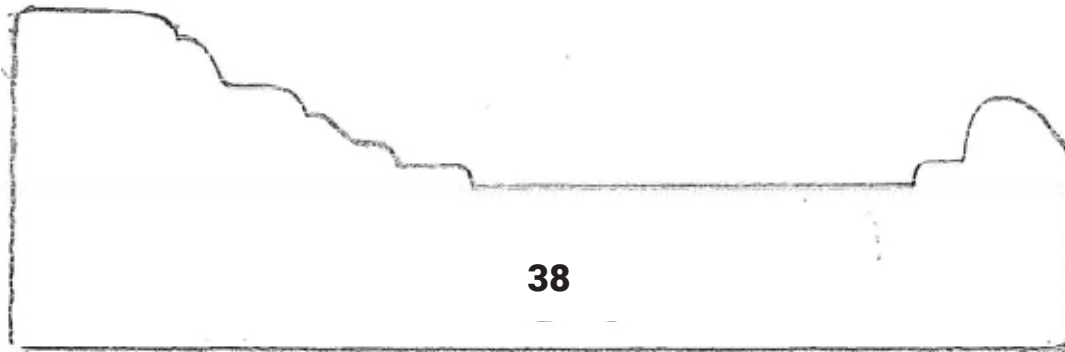

$1 3/4'' \times 5 1/2''$



$3/4'' \times 3 1/2''$

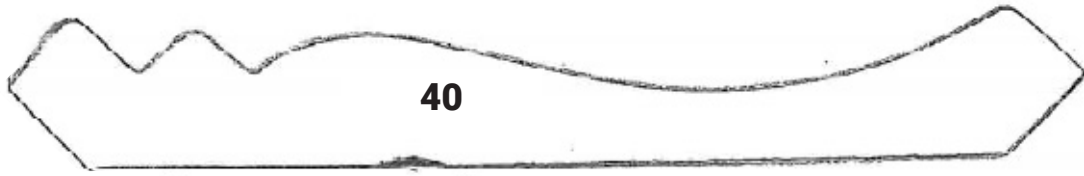

40

$3/4'' \times 5\ 1/2''$

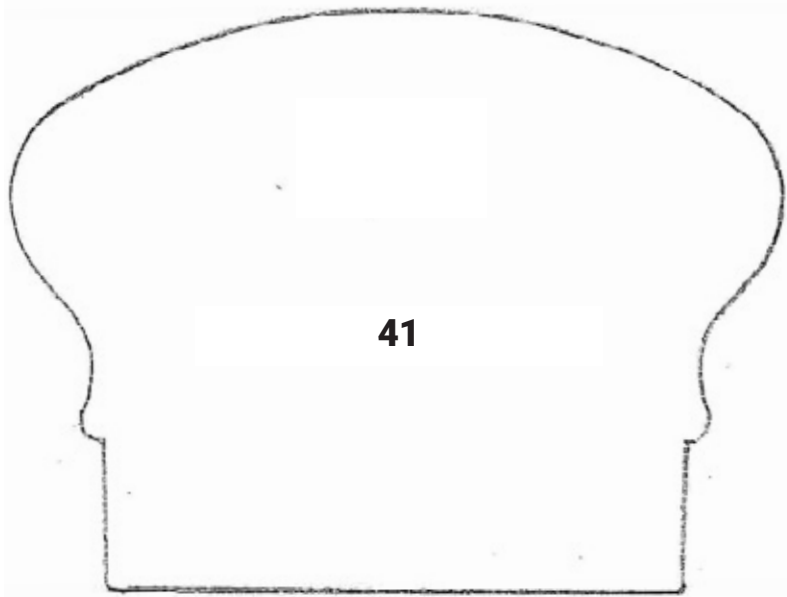

41

3" x 4"

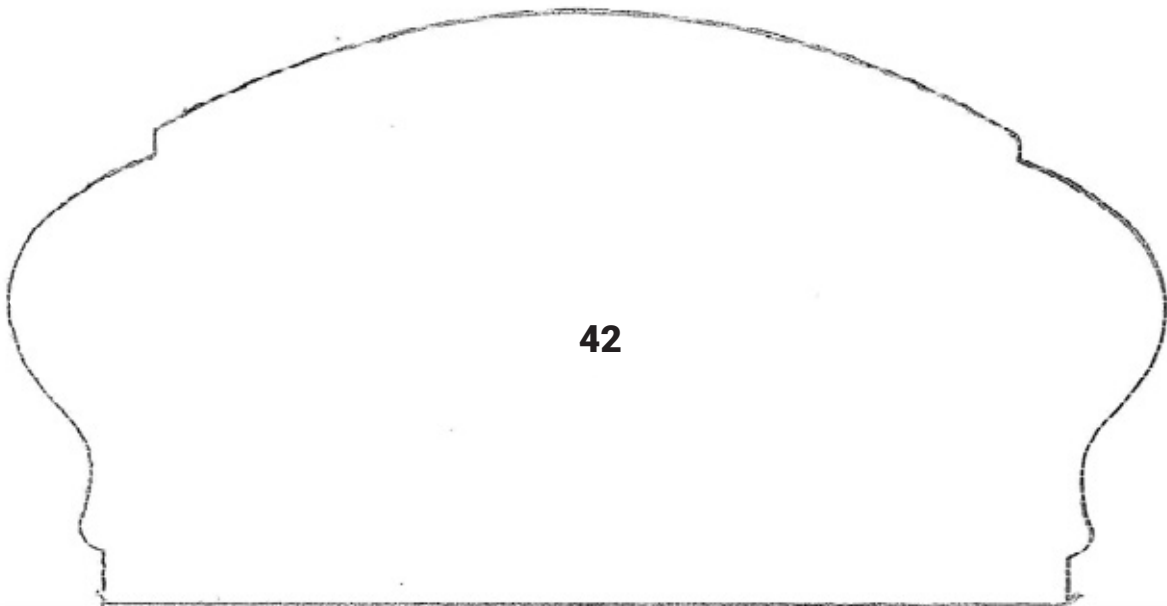

42

3" x 6"

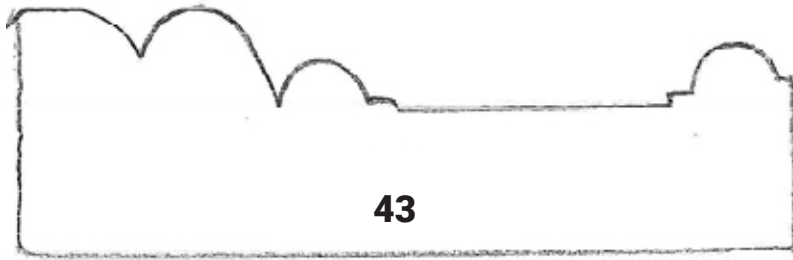

43

1 1/4" x 4"



44

3/4" x 3"



45

3/4" x ?"

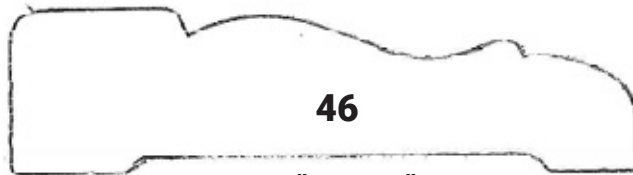

46

3/4" x 3 3/4"



47

3/4" x 4"
+ Base Wider 4 1/2"

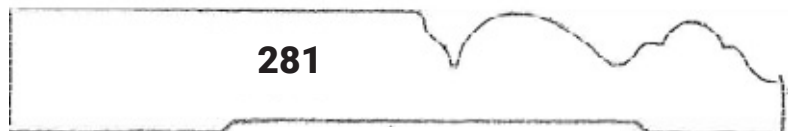

281

5/8" x 4 1/2"

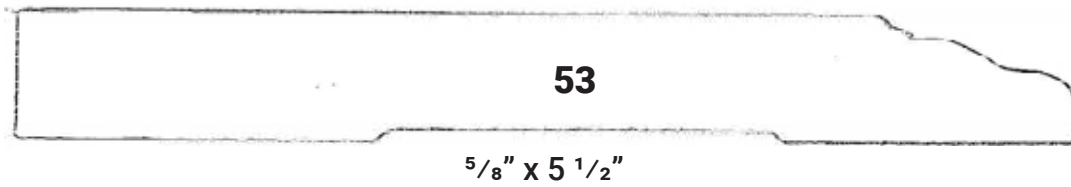
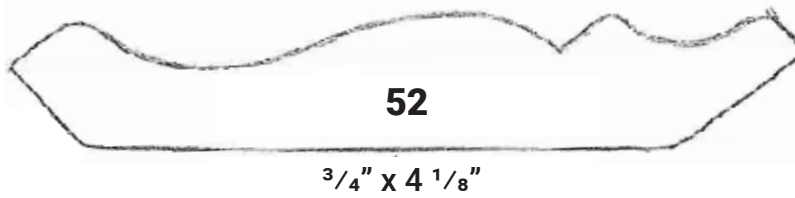
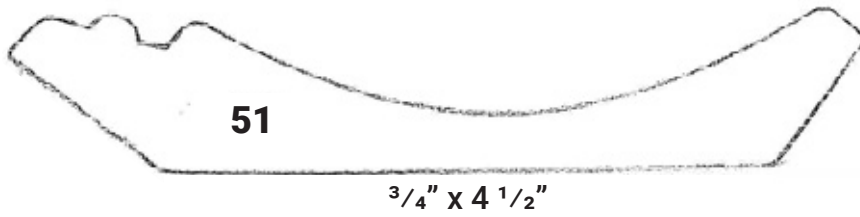
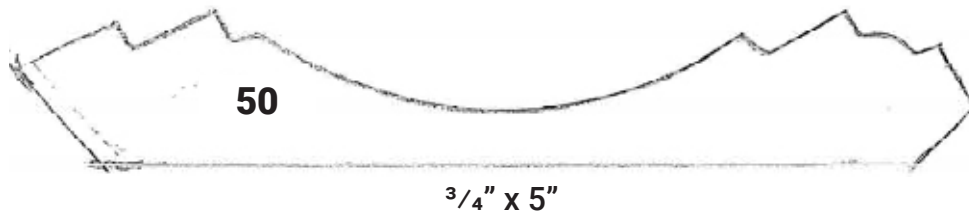
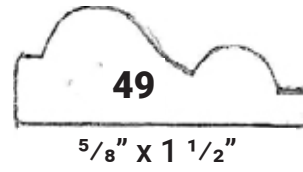
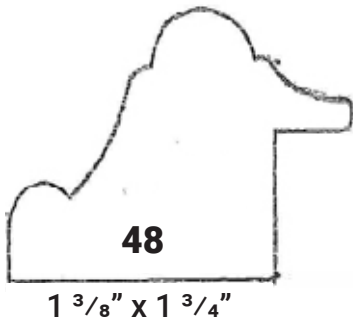

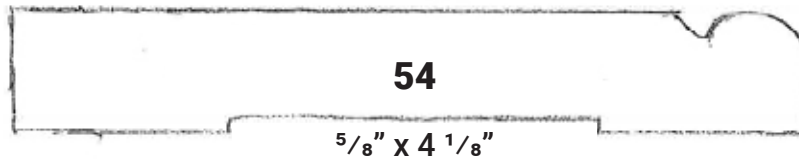

54

$\frac{5}{8}$ " X $4 \frac{1}{8}$ "

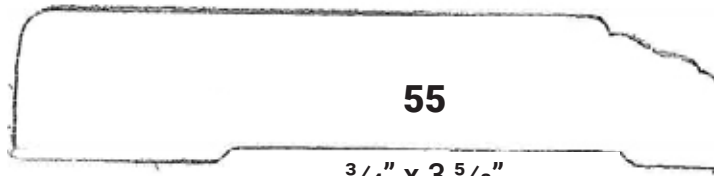

55

$\frac{3}{4}$ " X $3 \frac{5}{8}$ "

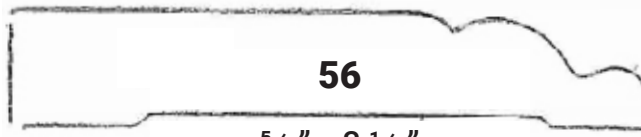

56

$\frac{5}{8}$ " X $3 \frac{1}{4}$ "

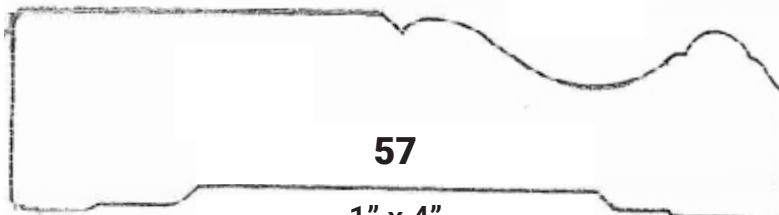

57

1" X 4"

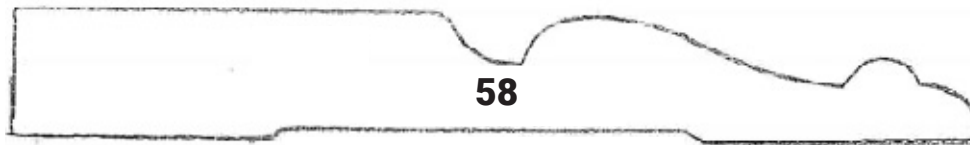

58

$\frac{11}{16}$ " X 5"

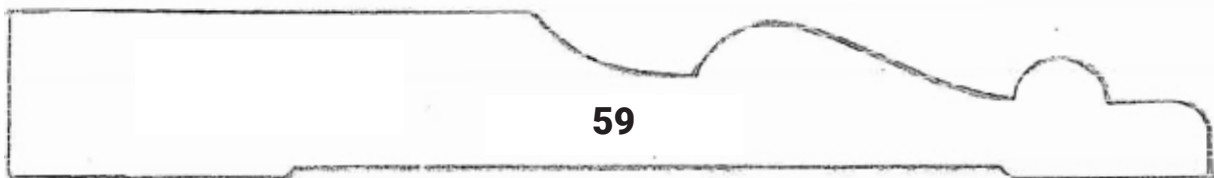

59

$\frac{7}{8}$ " X $6 \frac{1}{4}$ "

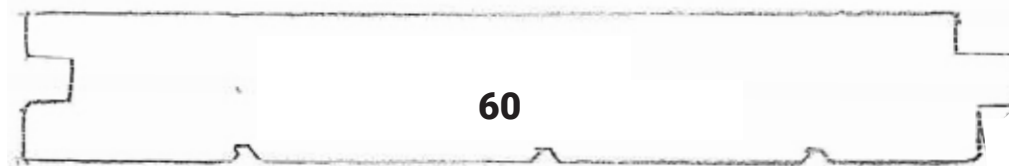

60

$\frac{3}{4}$ " X ?"

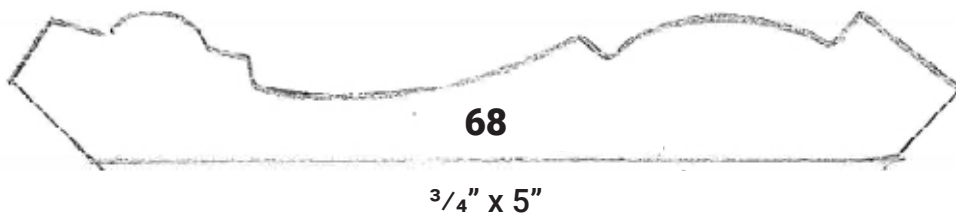
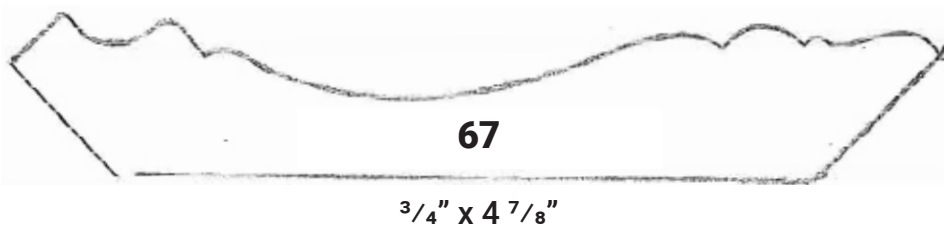
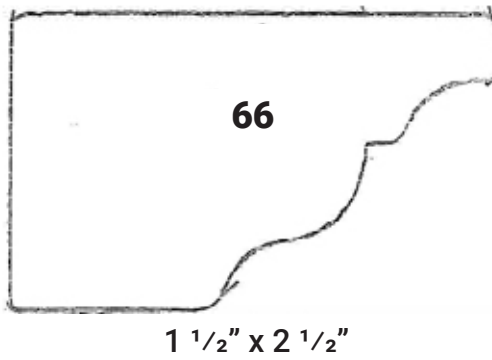
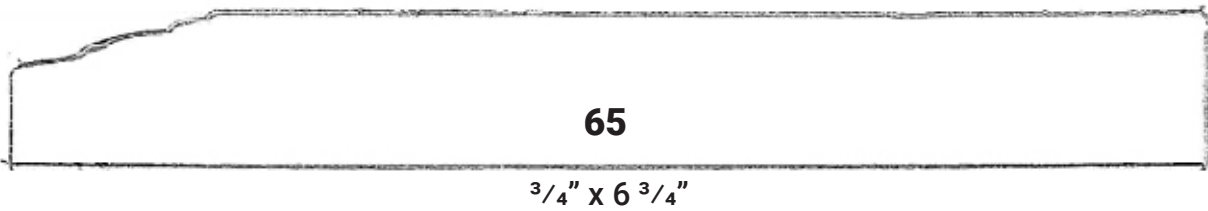
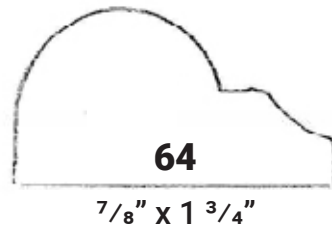
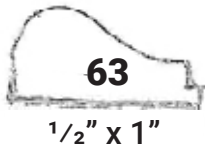
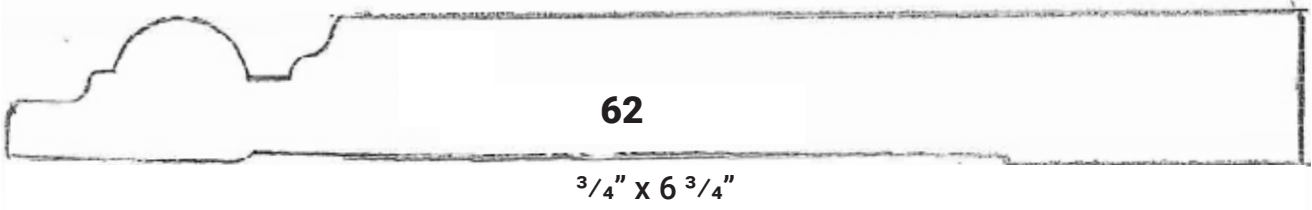
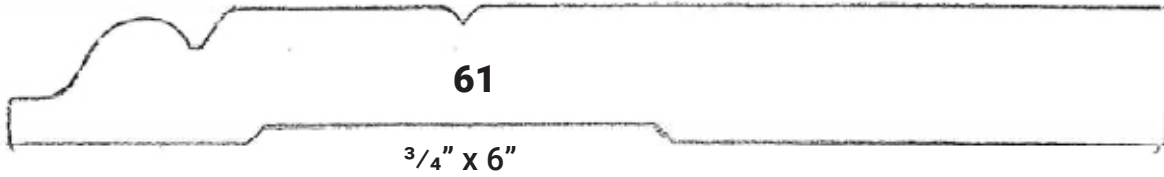

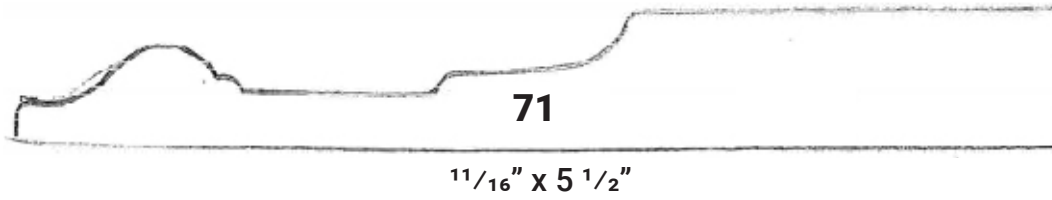
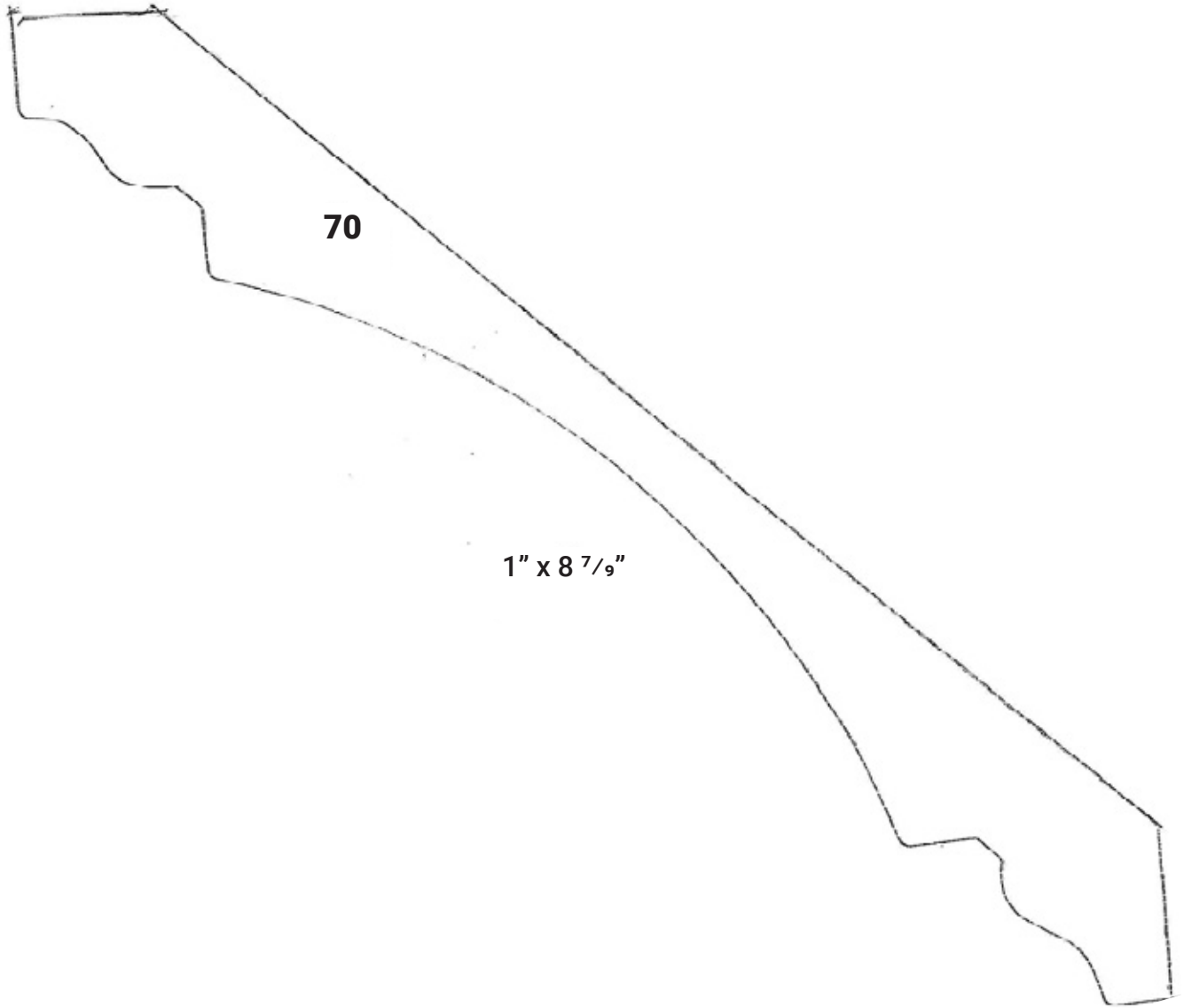
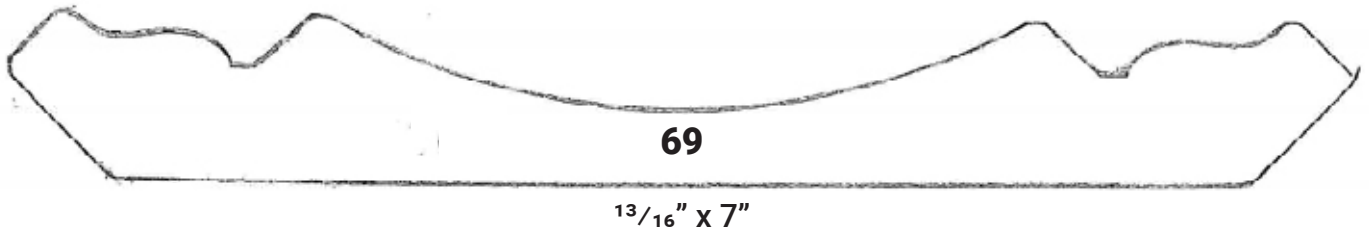

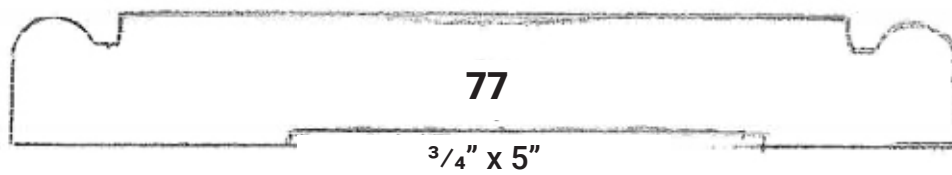
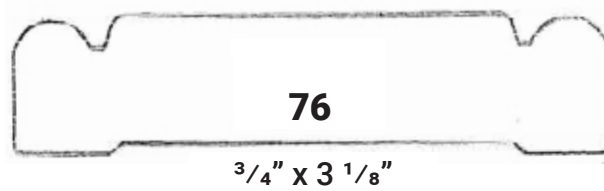
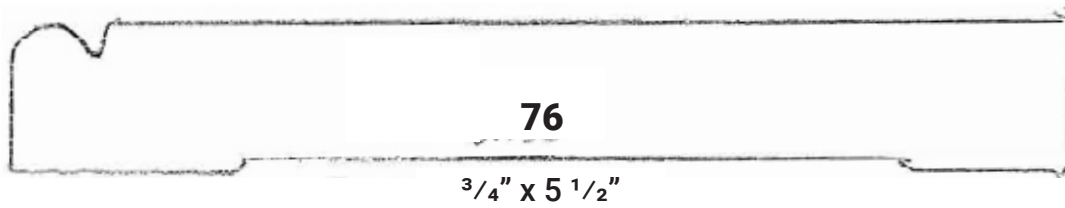
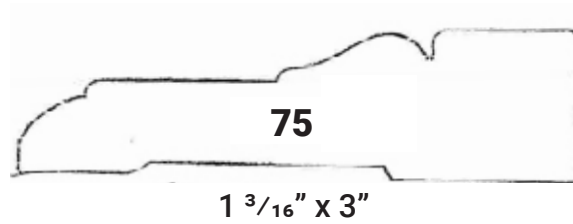
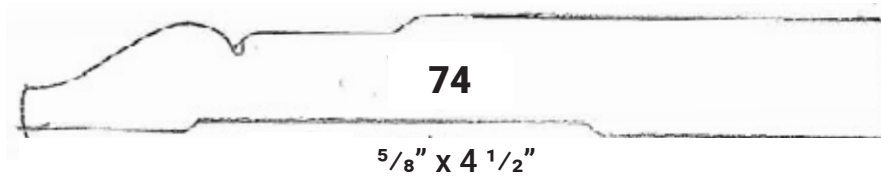
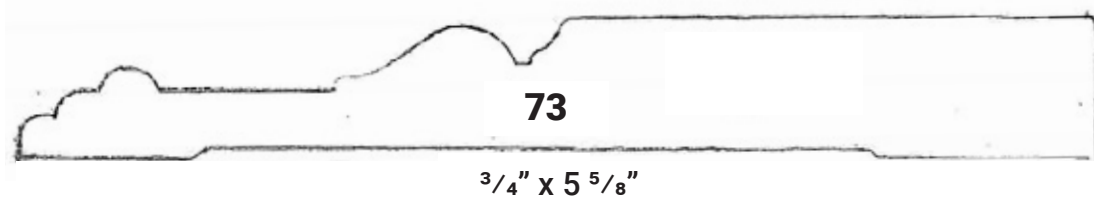
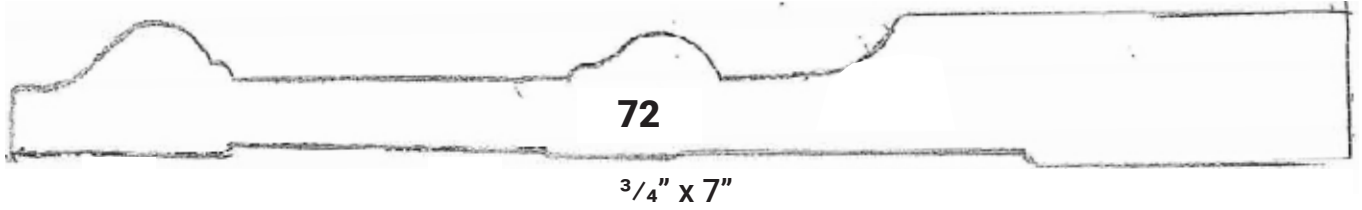

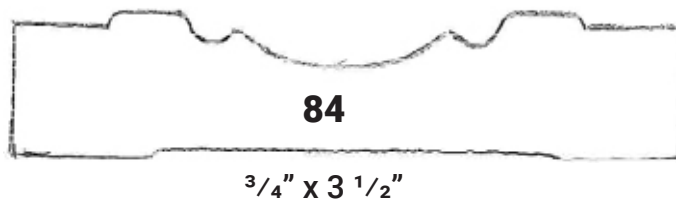
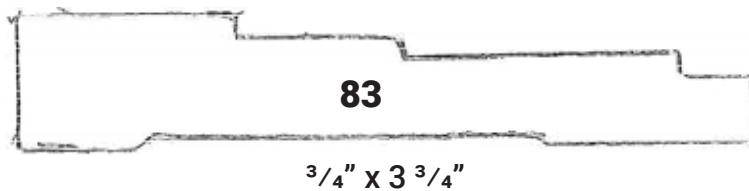
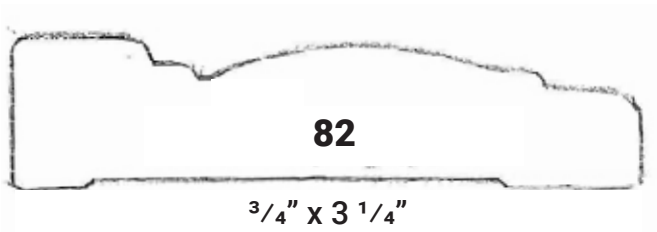
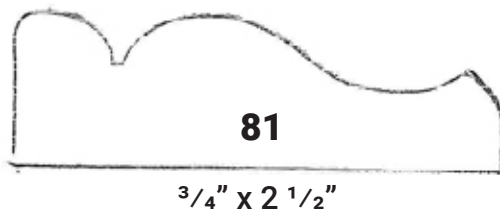
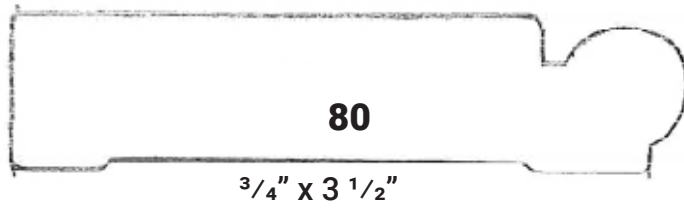
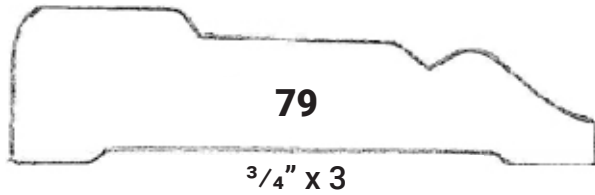
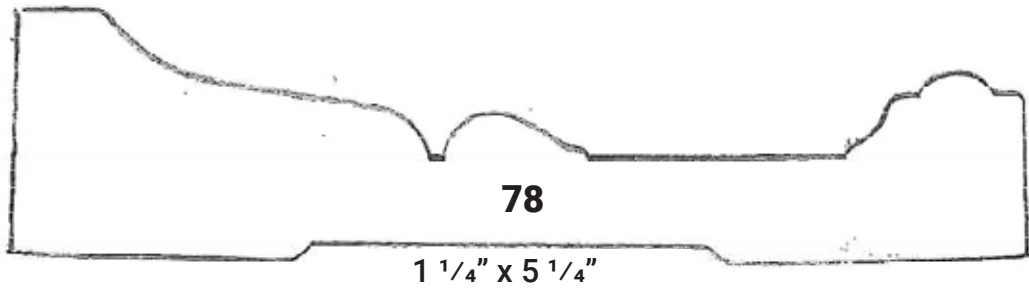

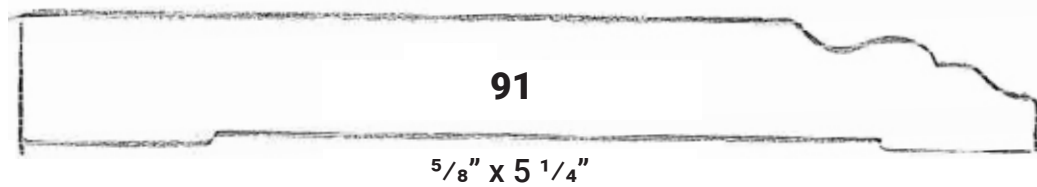
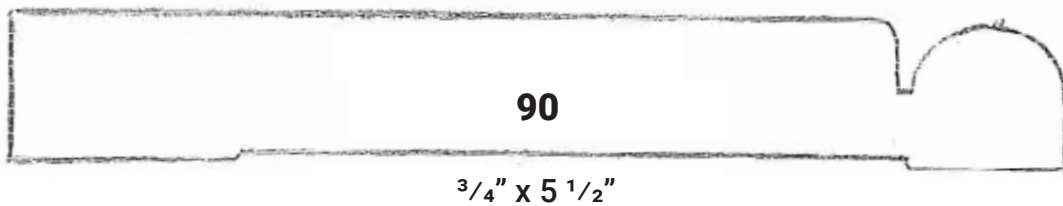
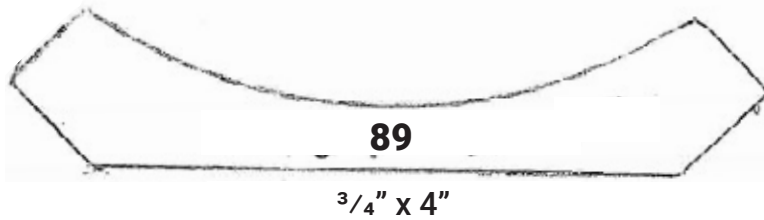
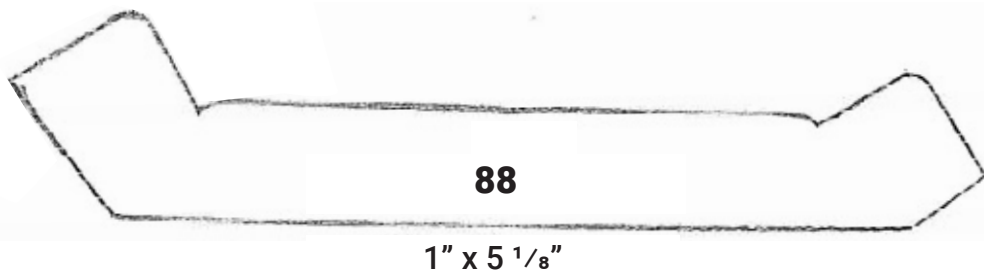
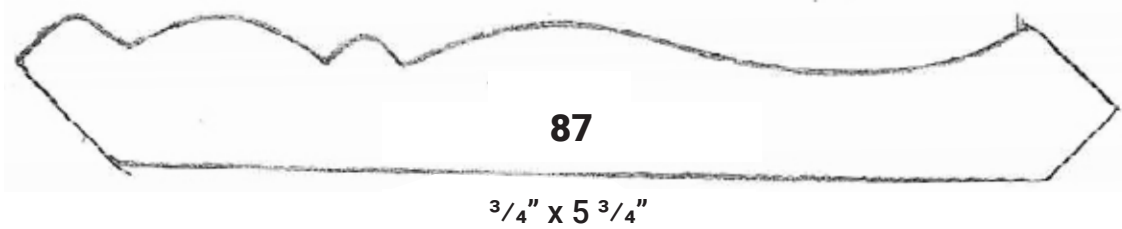
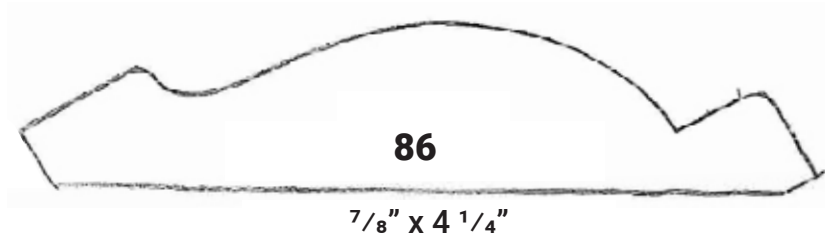
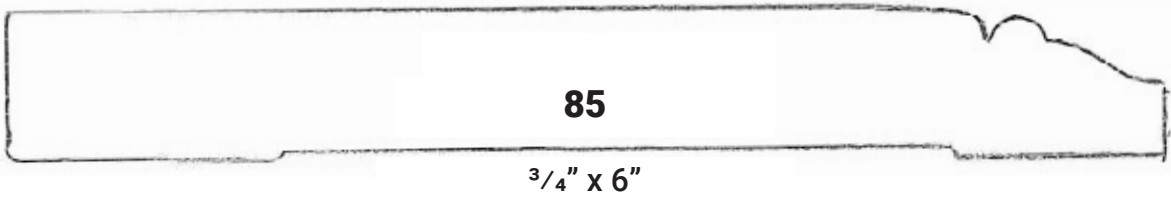

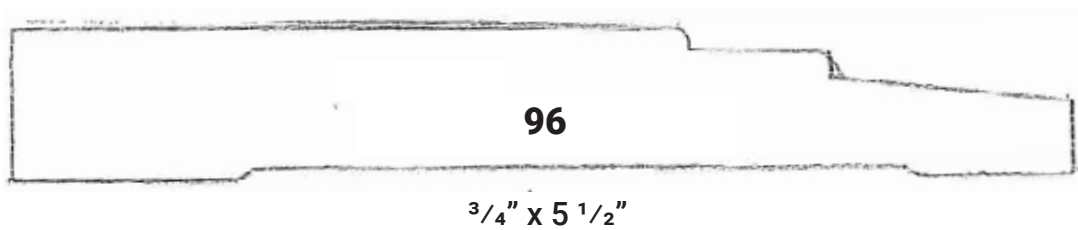
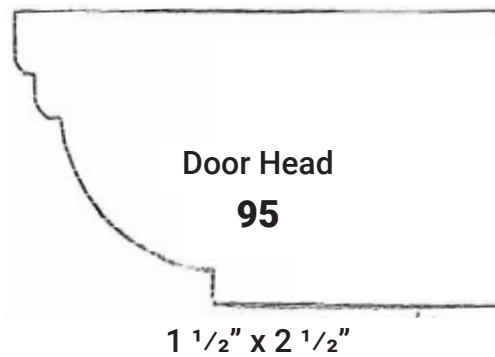
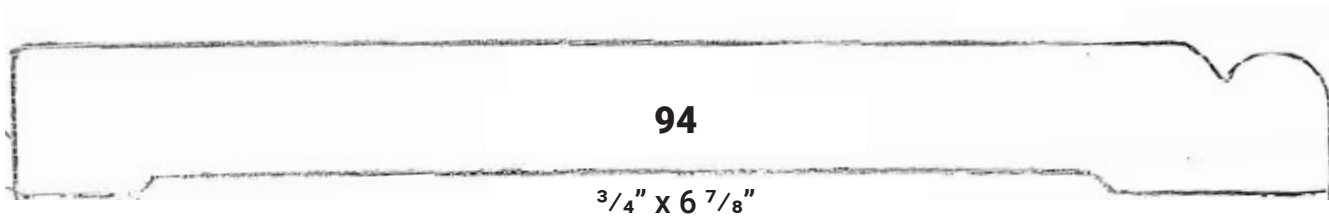
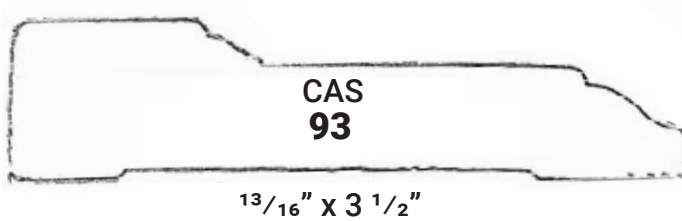
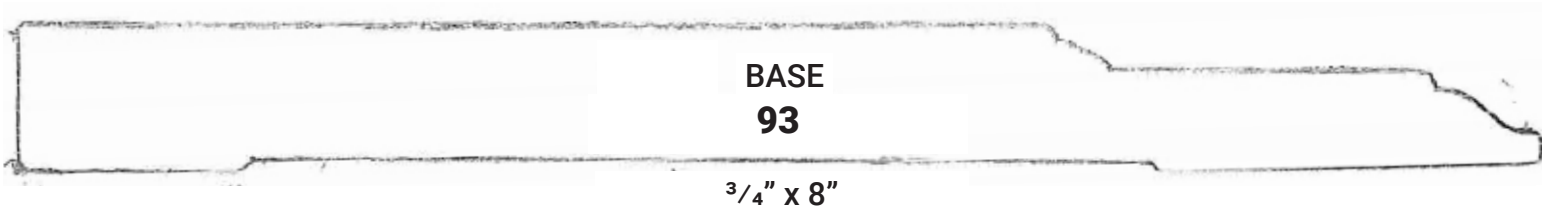
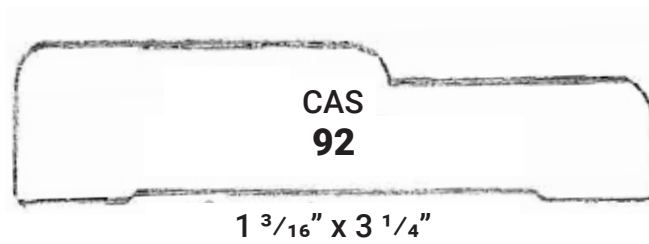
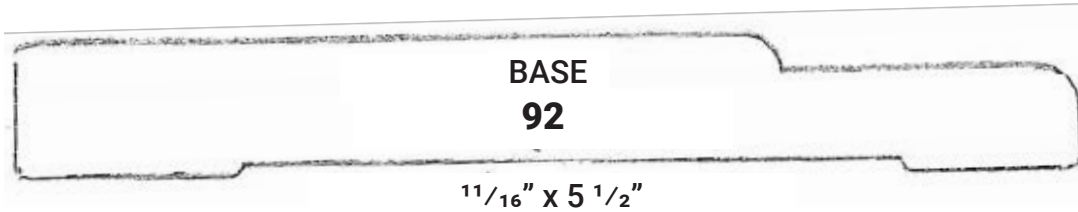

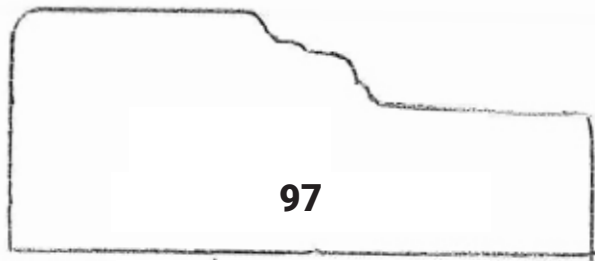

97

1 1/4" x 3"

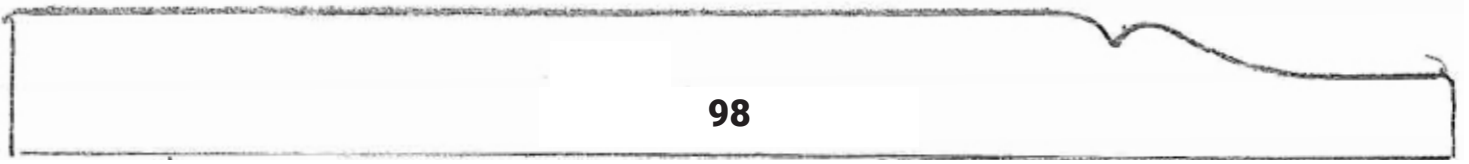

98

3/4" x 7 1/2"

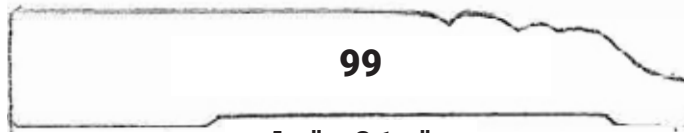

99

5/8" x 3 1/2"



100

9/16" x 5"

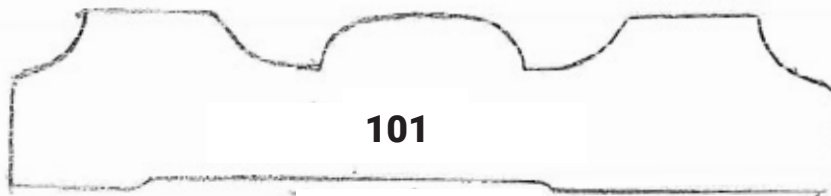

101

7/8" x 4 1/4"

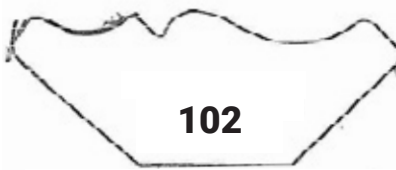

102

3/4" x 2"



103

3/4" x 5 3/8"

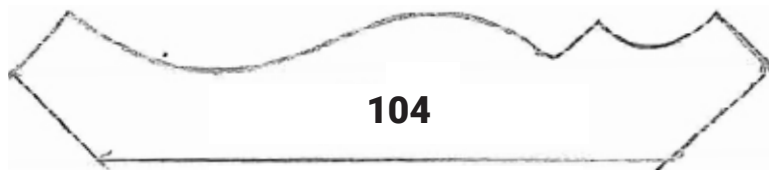

104

3/4" x 4"

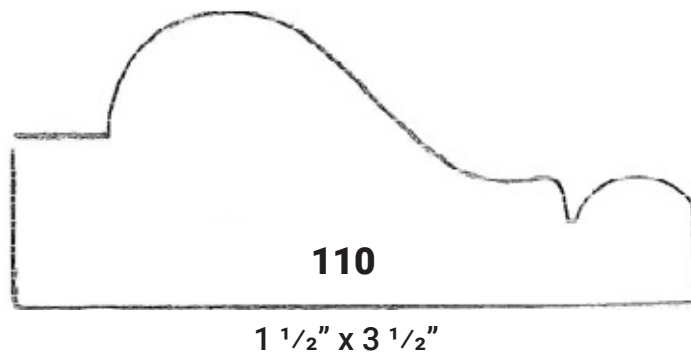
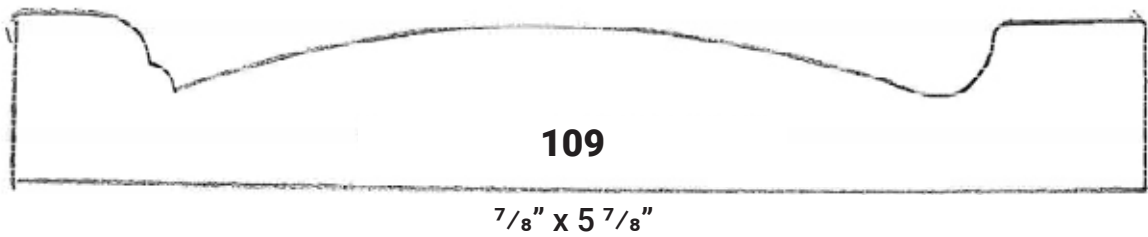
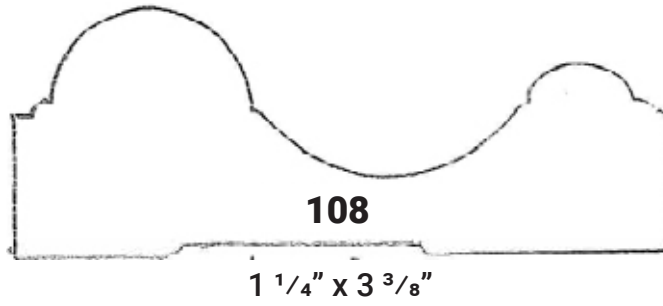
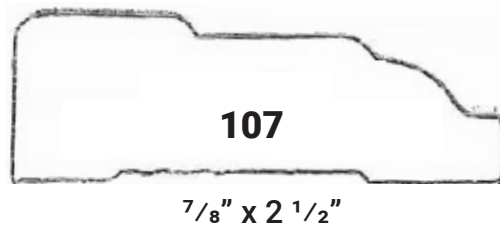
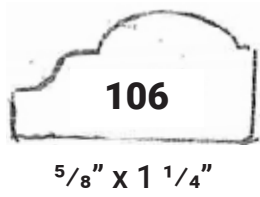
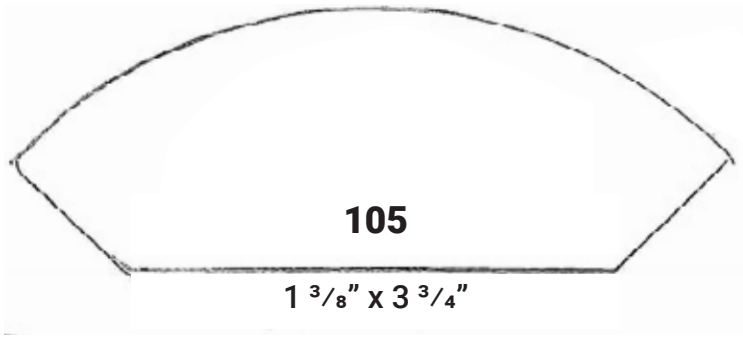

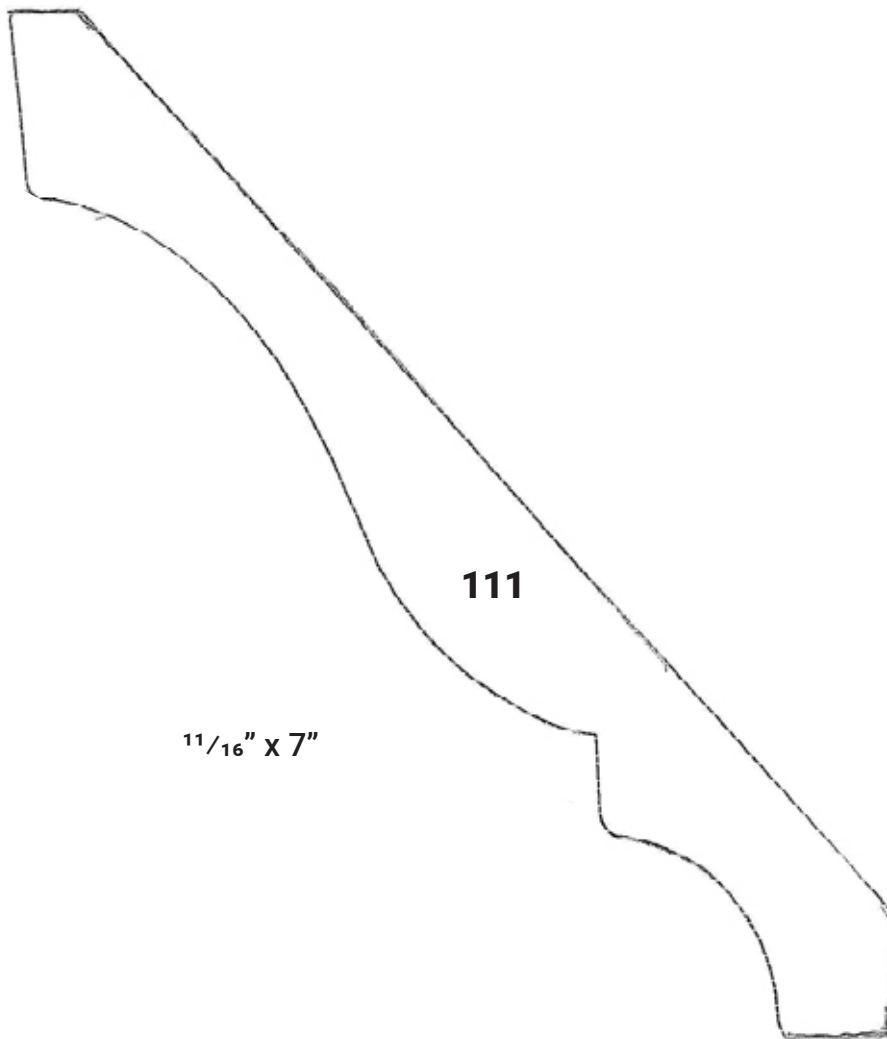

111

$1\frac{1}{16}'' \times 7''$

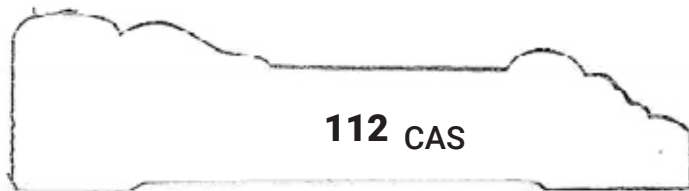

112 CAS

$\frac{7}{8}'' \times 3\frac{1}{2}''$

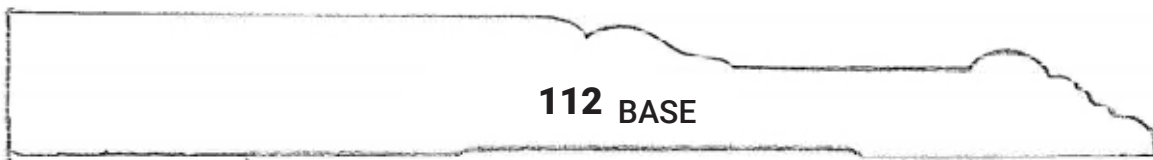

112 BASE

$\frac{3}{4}'' \times 6''$

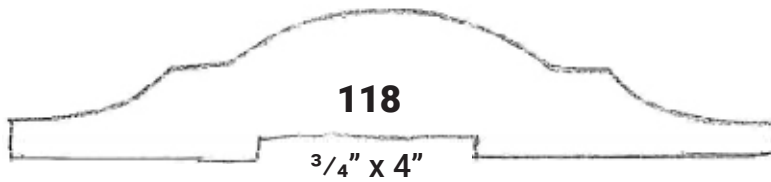
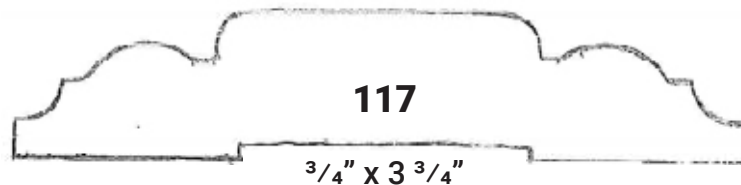
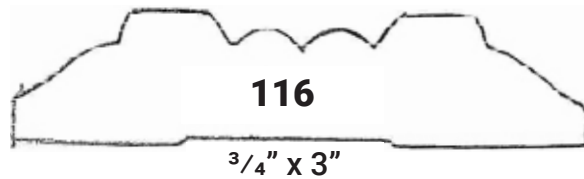
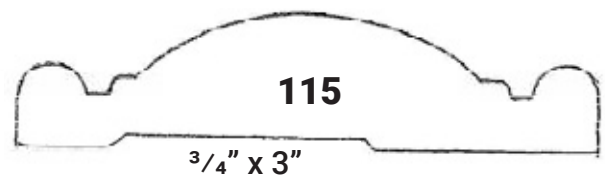
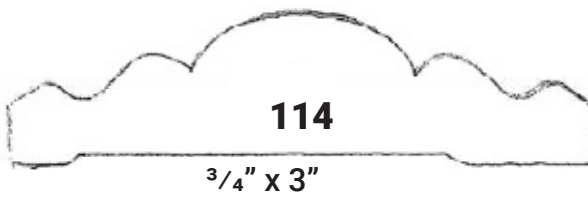
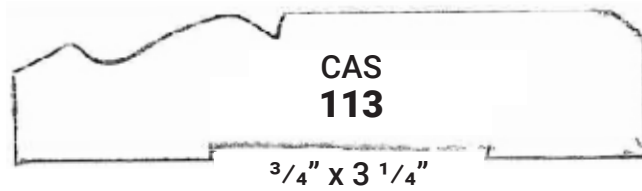
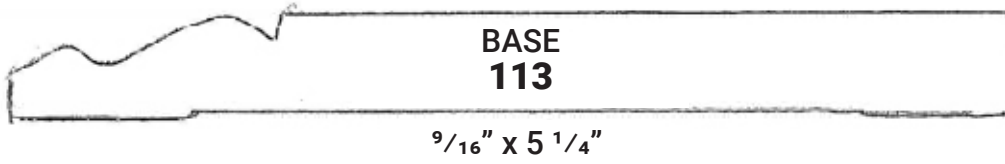

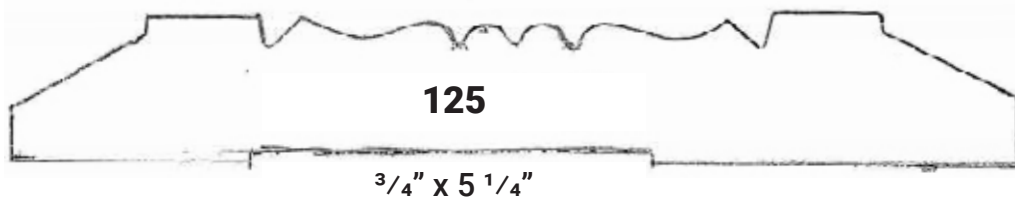
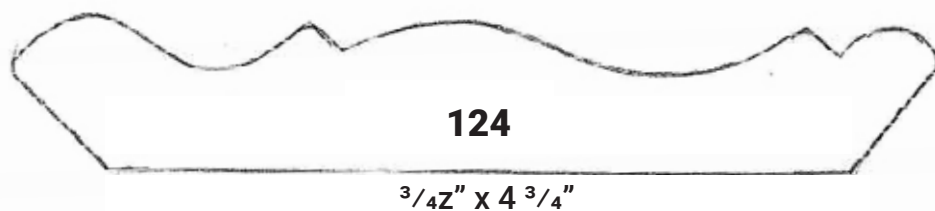
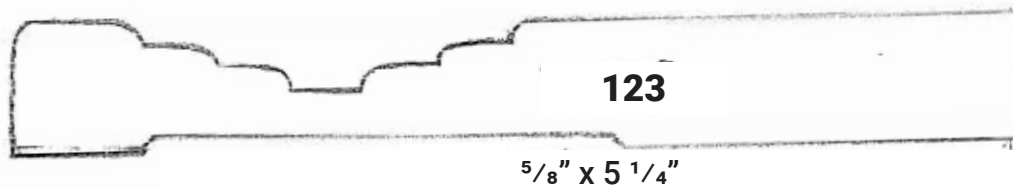
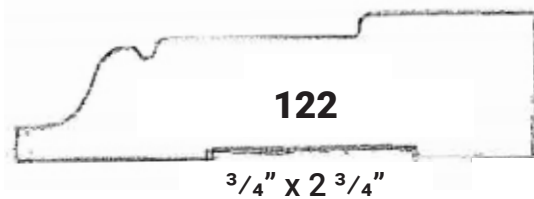
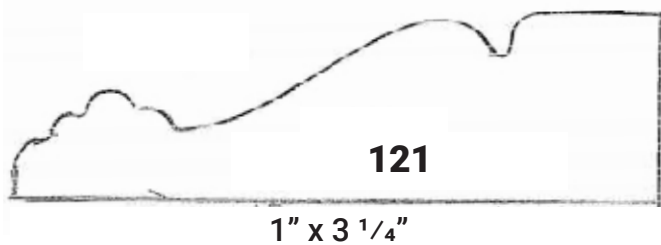
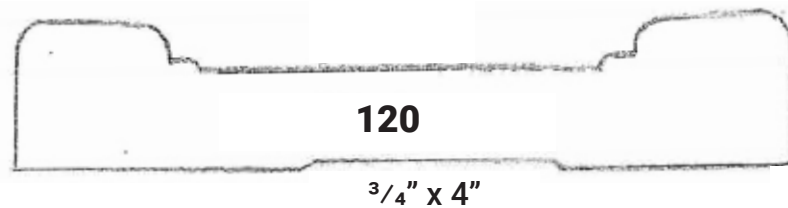
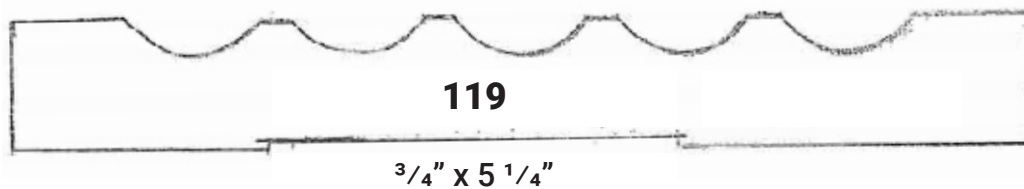

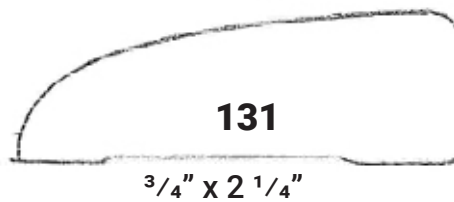
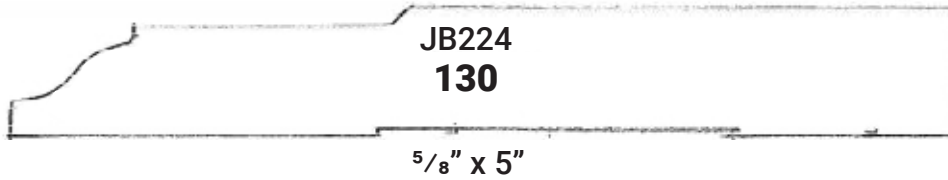
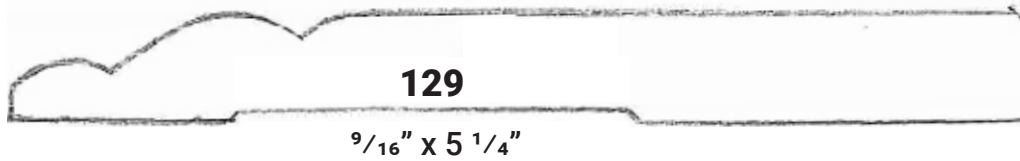
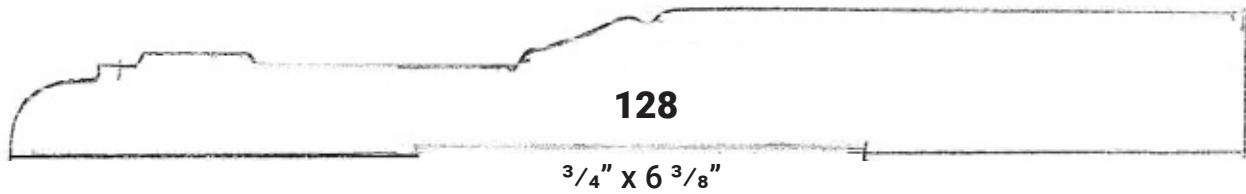
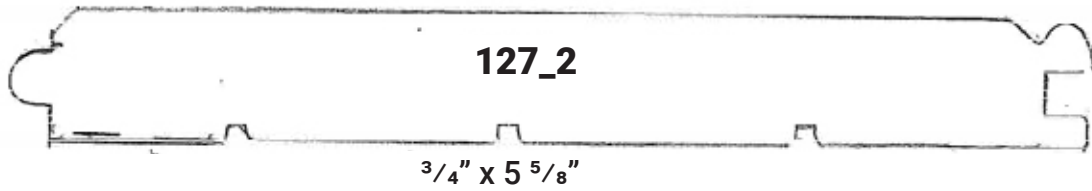
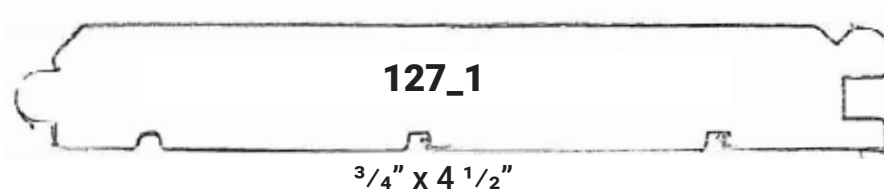
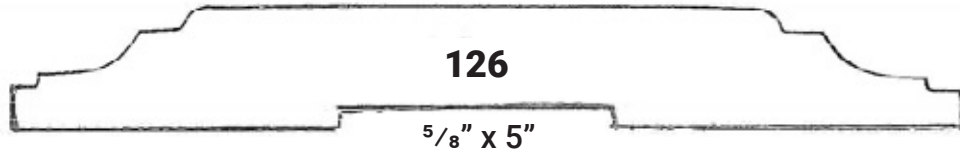



132

$3/4" \times 3 1/4"$



133

$5/8" \times 5 1/4"$

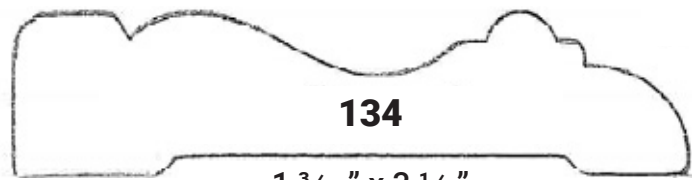

134

$1 3/16" \times 3 1/2"$

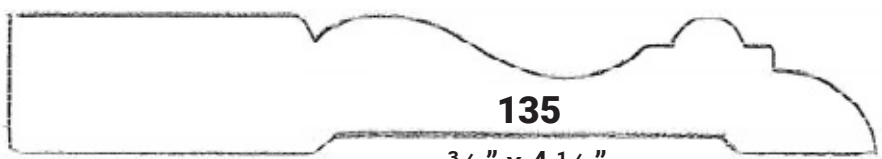

135

$3/4" \times 4 1/2"$

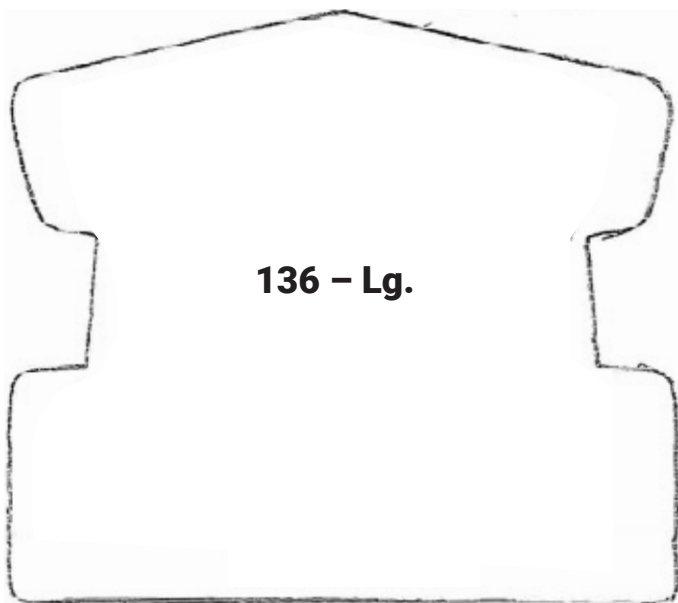

136 - Lg.

$3" \times 3 1/2"$

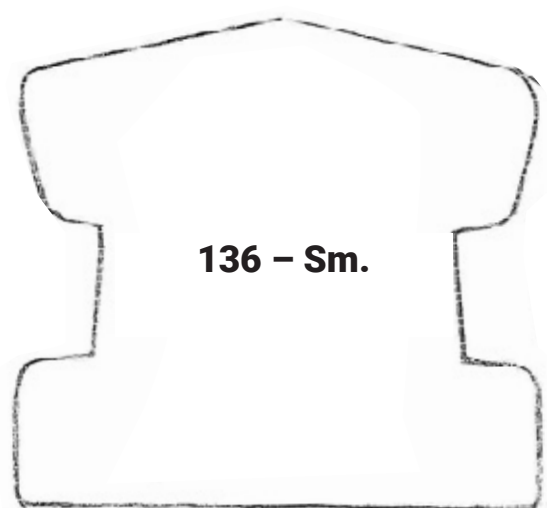

136 - Sm.

$2 1/2" \times 2 3/4"$

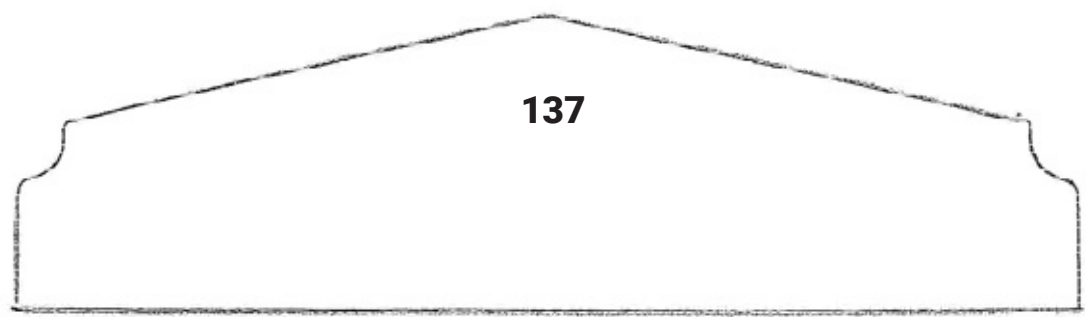

137

$1 1/2" \times 5 1/2"$

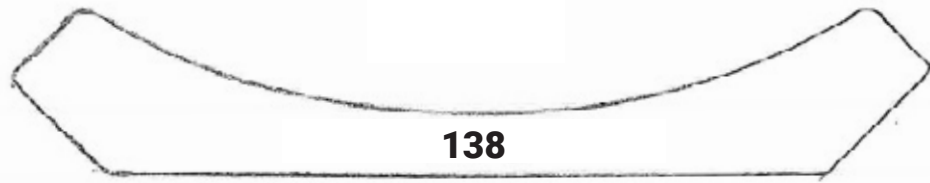

138

$7/8'' \times 4 \ 3/4''$



139

$3/4'' \times 3 \ 3/8''$



140

$5/8'' \times 5''$

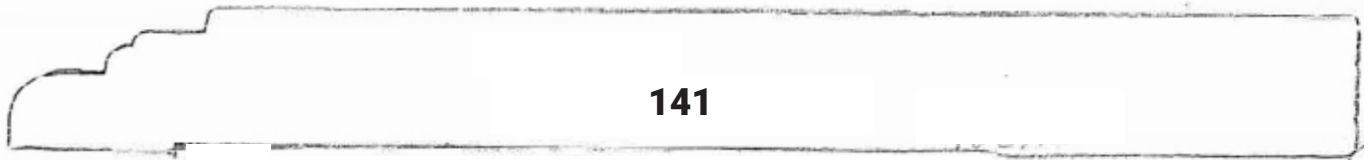

141

$3/4'' \times 7''$

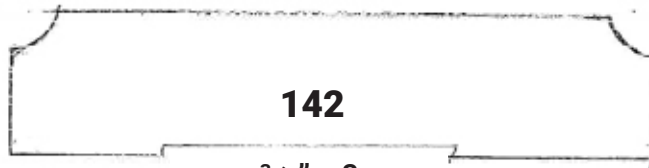

142

$3/4'' \times ?$

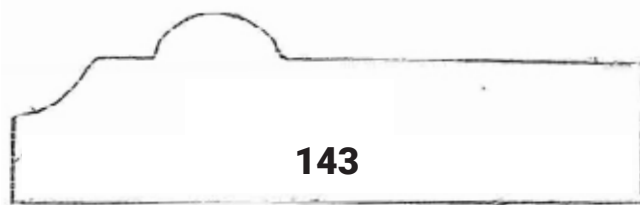

143

$1'' \times 3 \ 1/4''$

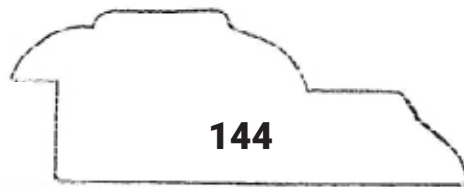

144

$7/8'' \times 2 \ 3/8''$

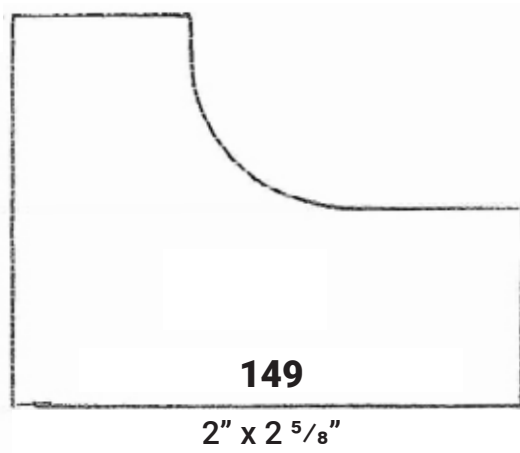
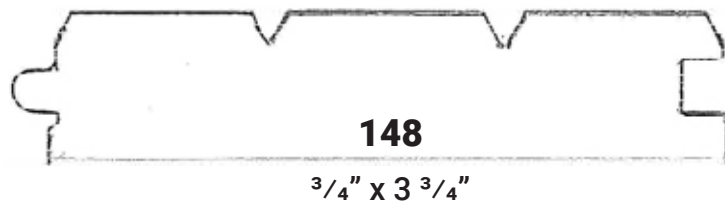
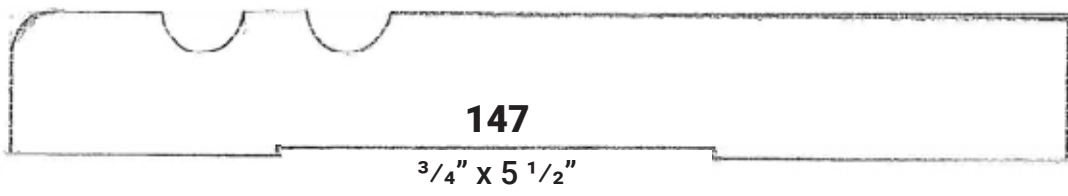
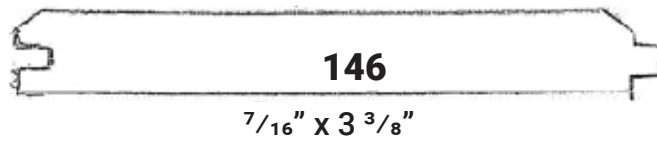
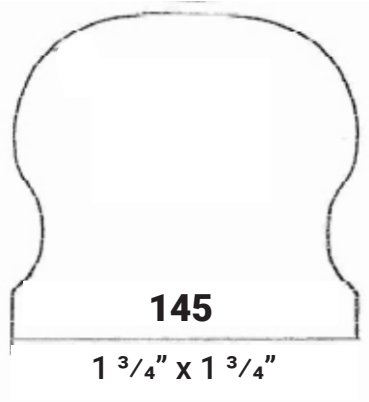

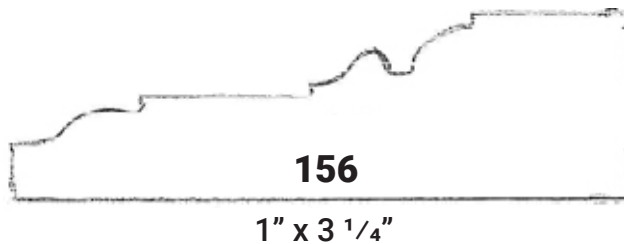
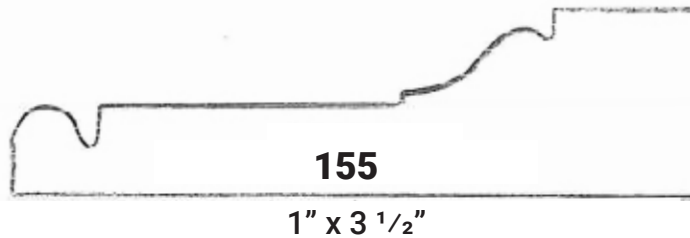
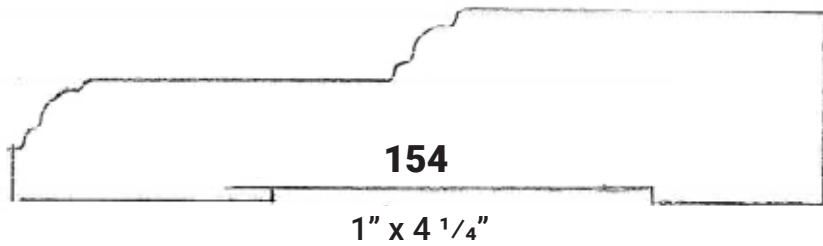
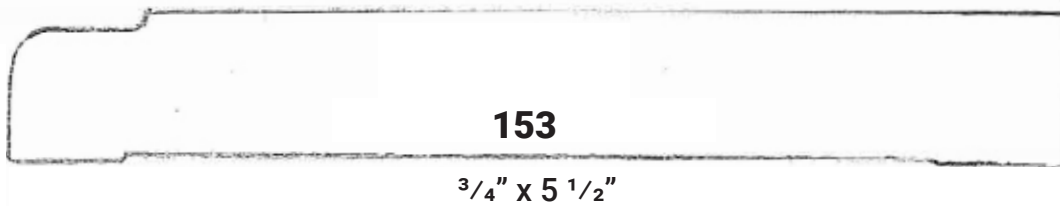
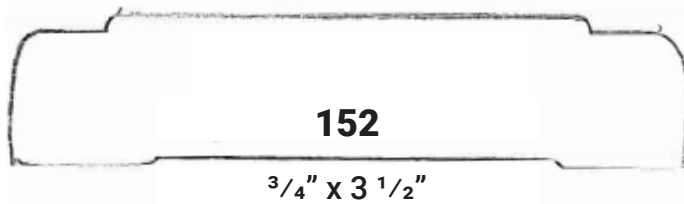
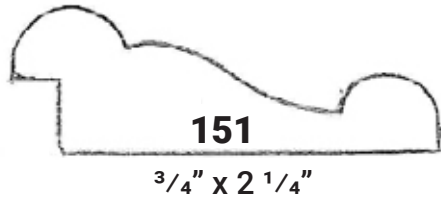
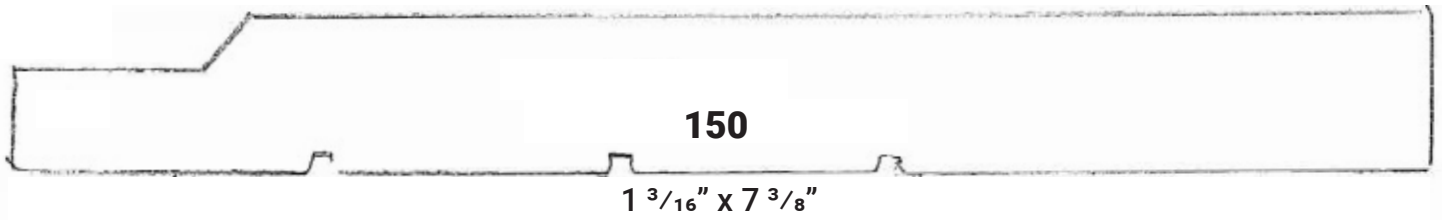

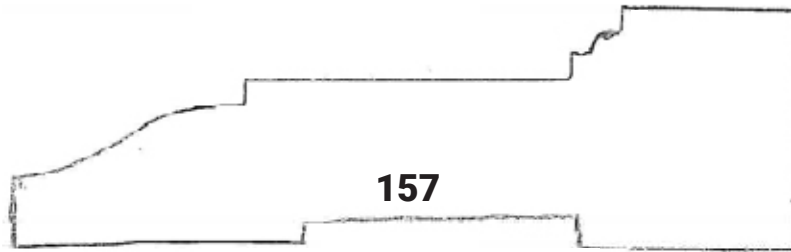

157

$1\frac{1}{4}'' \times 4''$



158

$1'' \times 4''$



159

$\frac{5}{8}'' \times 5\frac{5}{8}''$

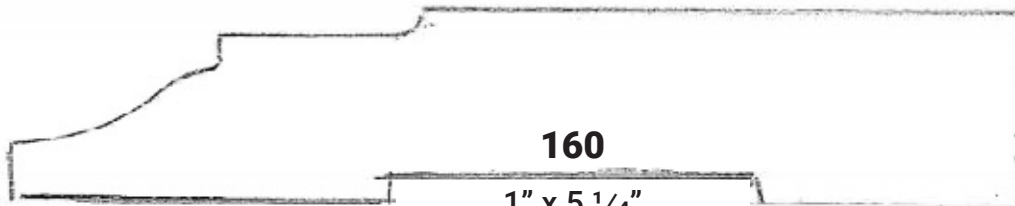

160

$1'' \times 5\frac{1}{4}''$



161

$1\frac{1}{16}'' \times 4''$



162

$1\frac{1}{16}'' \times 3\frac{1}{2}''$



163

$\frac{3}{4}'' \times 2\frac{3}{4}''$

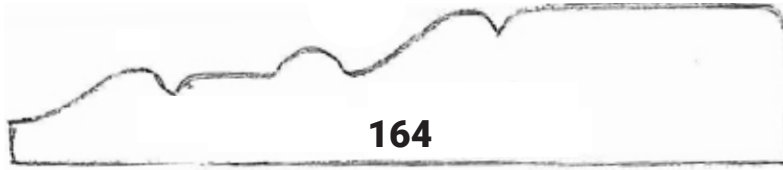

164

$\frac{3}{4}$ " X 4"

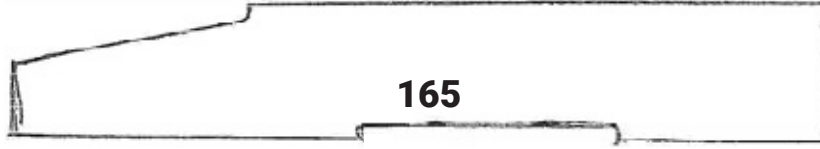

165

$\frac{3}{4}$ " X 4 $\frac{1}{4}$ "

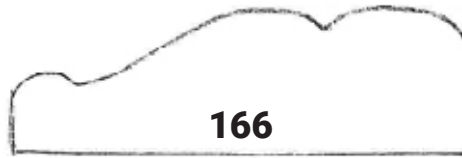

166

$\frac{3}{4}$ " X 2 $\frac{3}{8}$ "

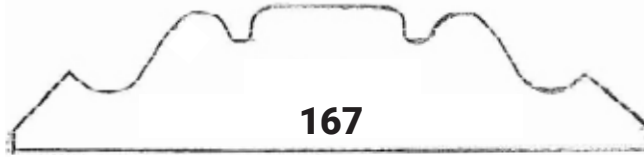

167

$\frac{3}{4}$ " X 3 $\frac{1}{4}$ "

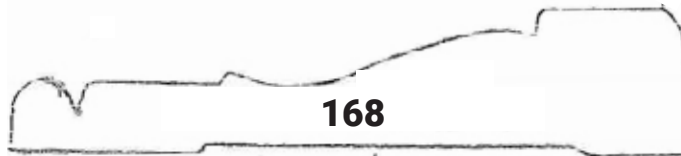

168

$\frac{3}{4}$ " X 3 $\frac{1}{2}$ "

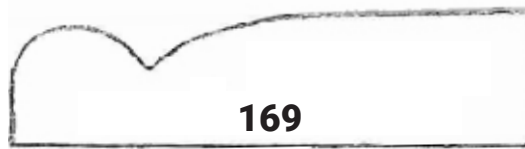

169

$\frac{11}{16}$ " X 2 $\frac{1}{4}$ "

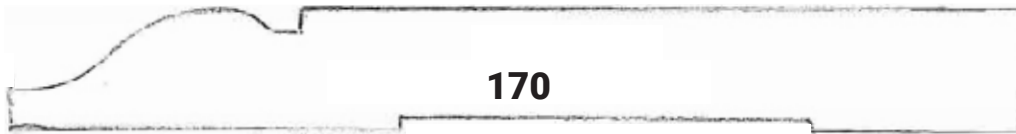

170

$\frac{5}{8}$ " X 5 $\frac{1}{4}$ "

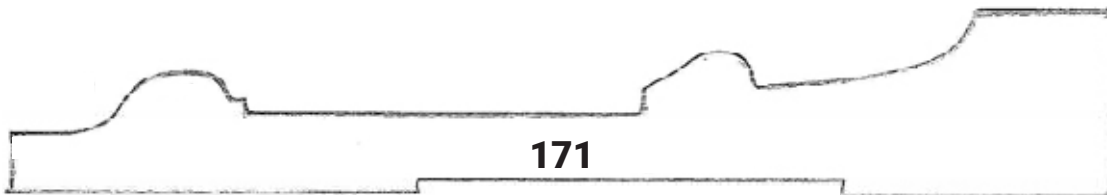

171

1 X 5 $\frac{3}{4}$ "

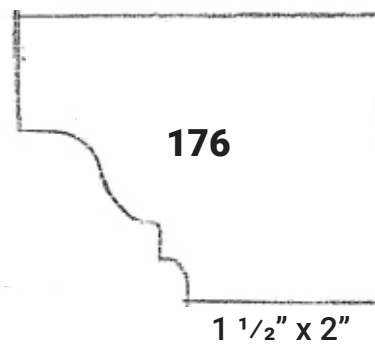
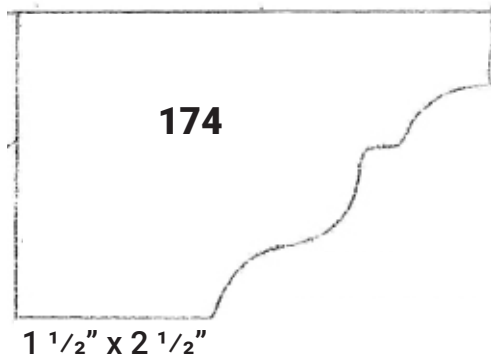
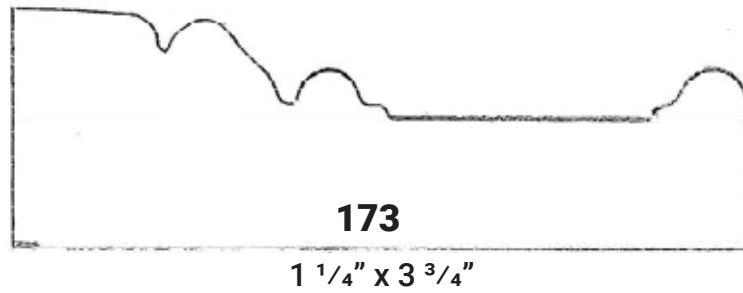
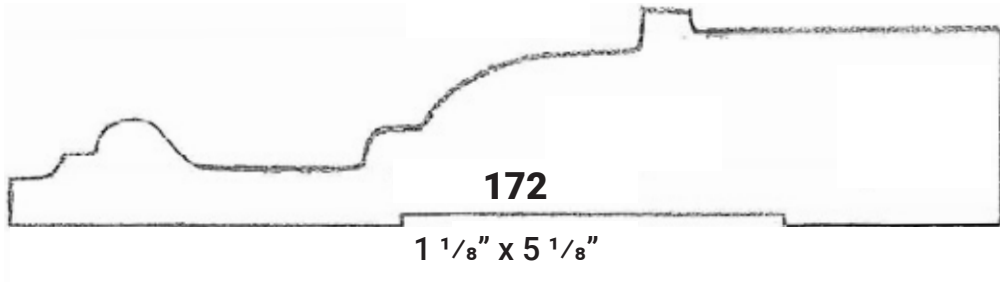

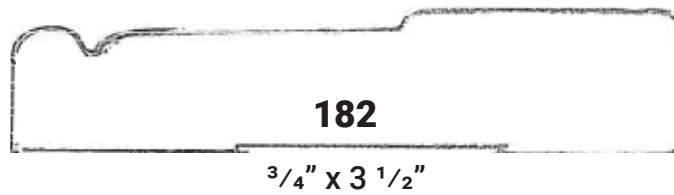
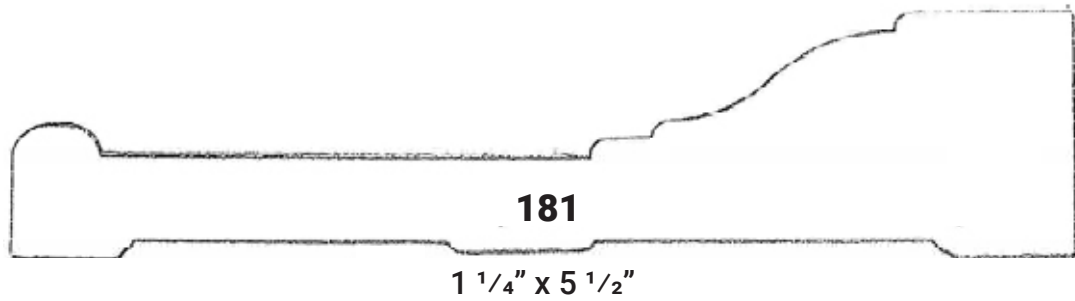
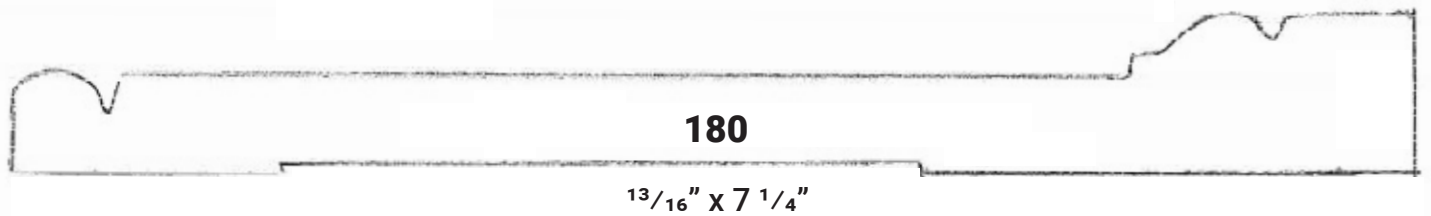
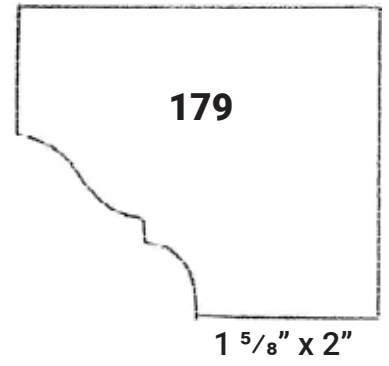
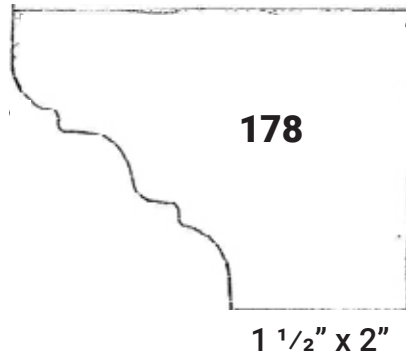
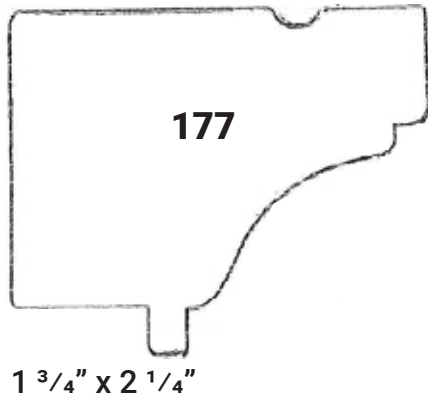



183

$\frac{3}{4}$ " X 7"



184

$\frac{9}{16}$ " X 6 $\frac{1}{2}$ "

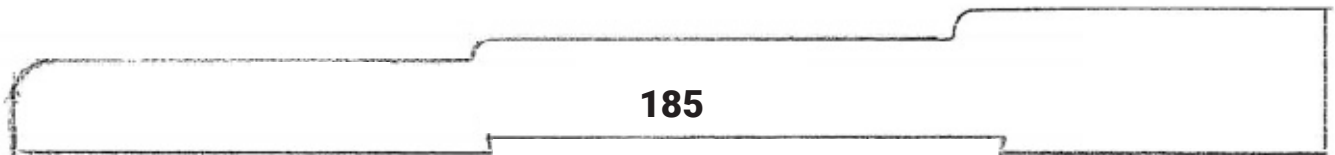

185

$\frac{3}{4}$ " X 6 $\frac{3}{4}$ "

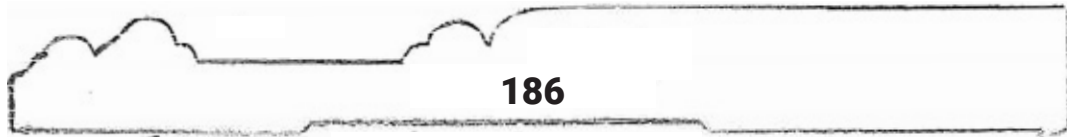

186

$\frac{5}{8}$ " X 5 $\frac{1}{2}$ "

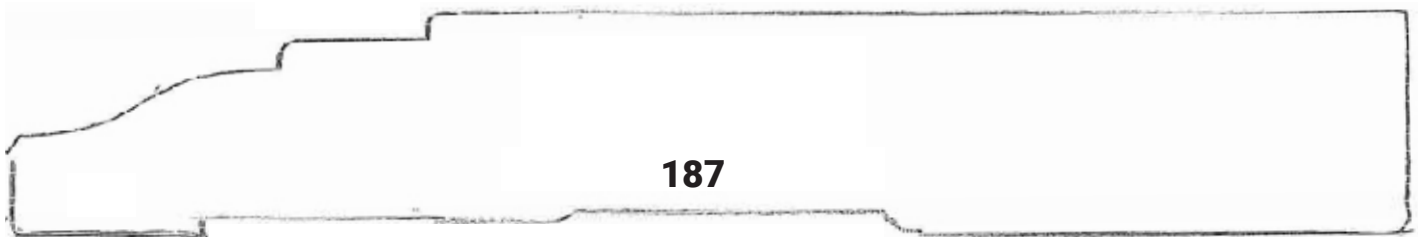

187

1 $\frac{1}{8}$ " X 7 $\frac{1}{4}$ "



188

$\frac{3}{4}$ " X 5"

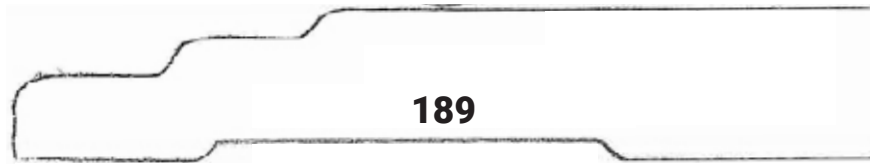

189

$3/4" \times 4 1/2"$

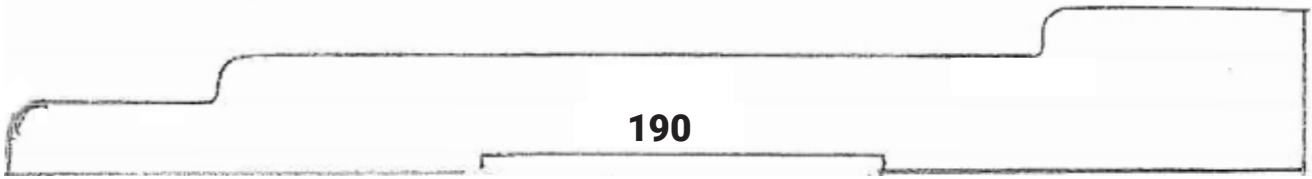

190

$1 3/16" \times 6 3/4"$



191

$3/4" \times 5 1/2"$

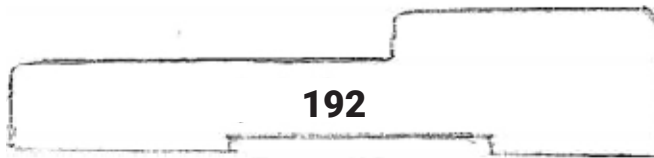

192

$3/4" \times 3 3/8"$



193

$1 1/4" \times 4"$

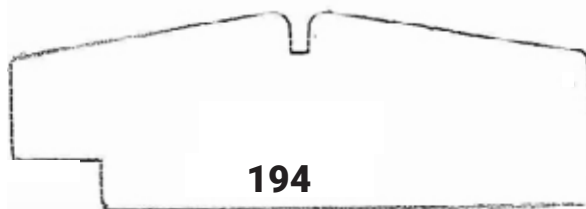

194

$1" \times 3"$

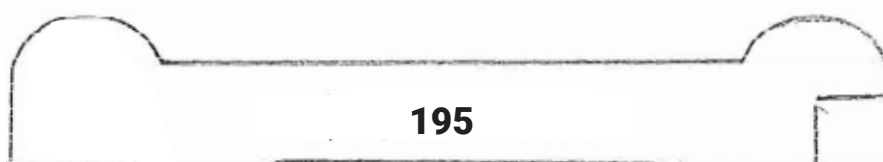

195

$3/4" \times 4 1/2"$

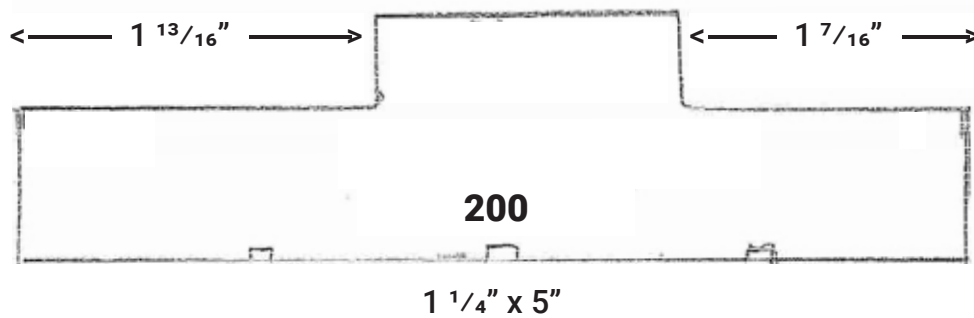
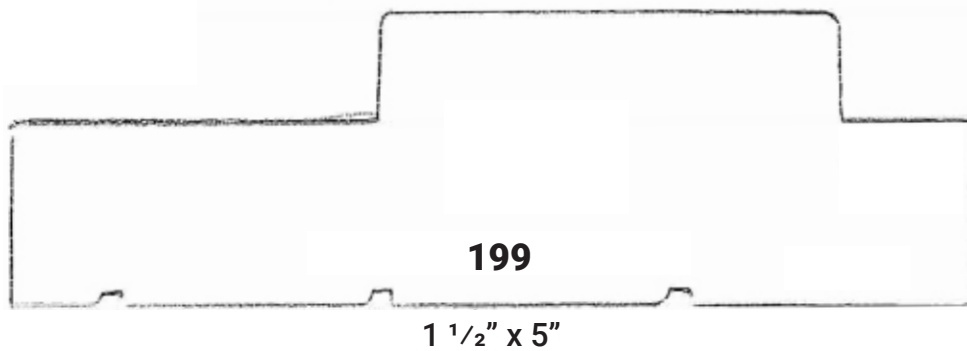
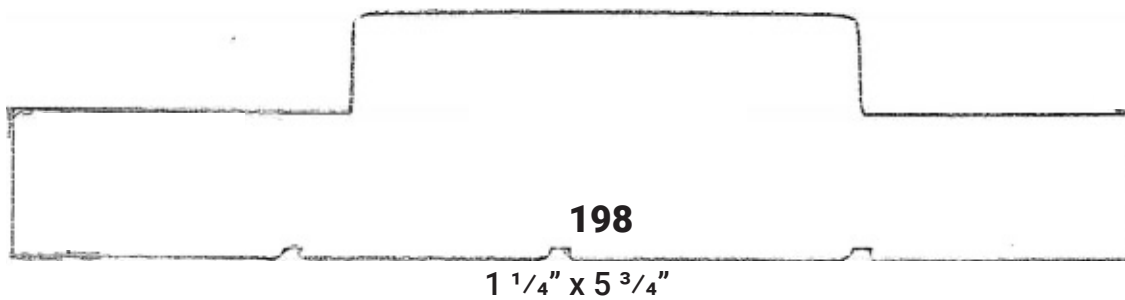
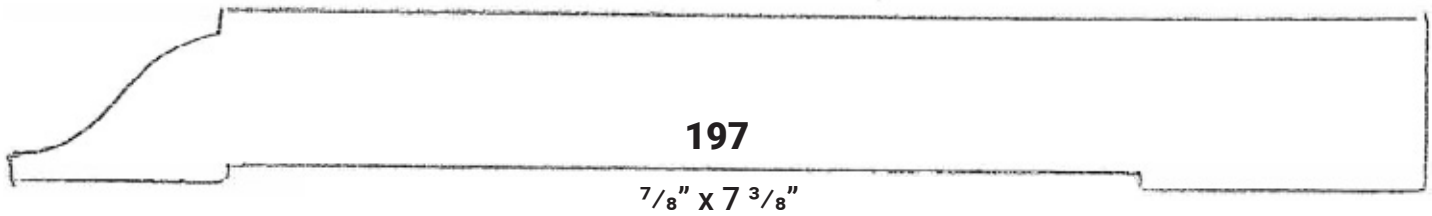
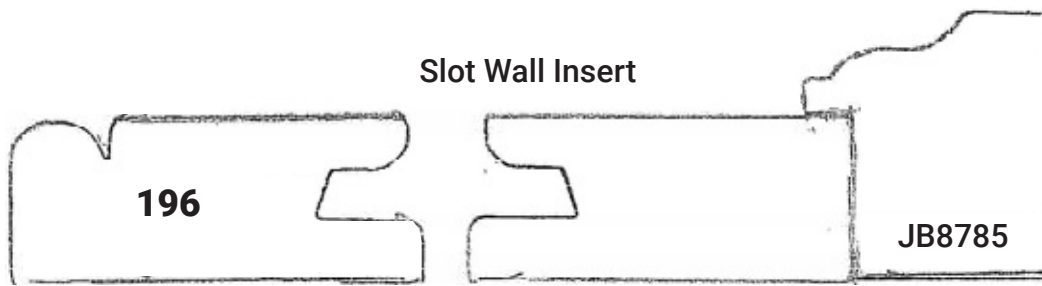



201

$7/8" \times 2 7/8"$

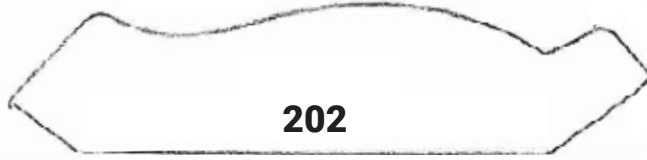

202

$3/4" \times 3 3/4"$

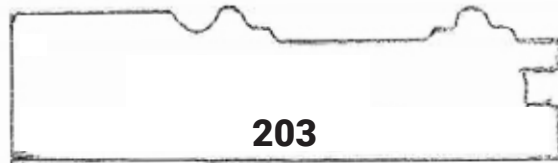

203

$3/4" \times 2 7/8"$



204

$5/8" \times 2 7/8"$

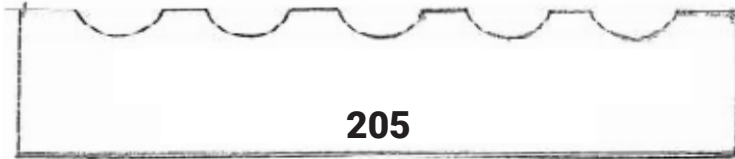

205

$3/4" \times 3 3/4"$



206

$9/16" \times 2 3/8"$

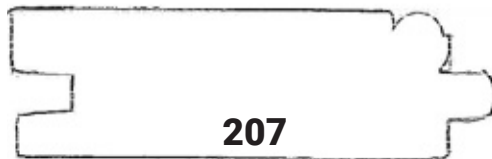

207

$3/4" \times 2 1/2"$

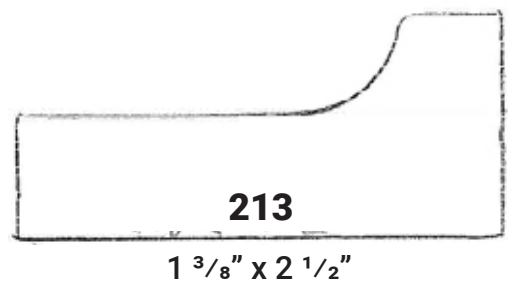
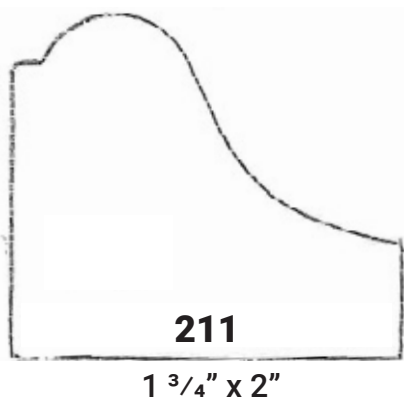
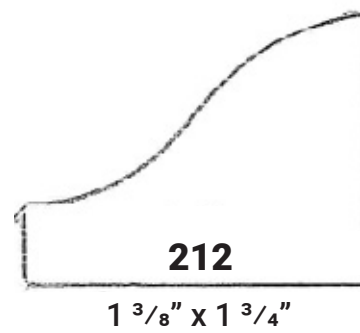
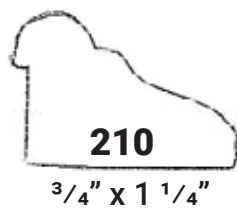
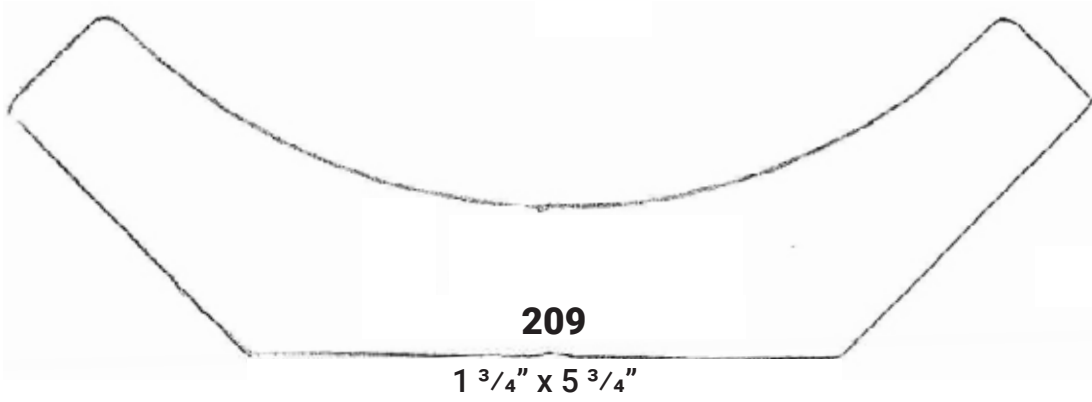
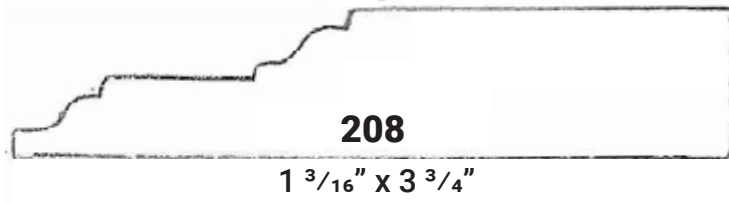

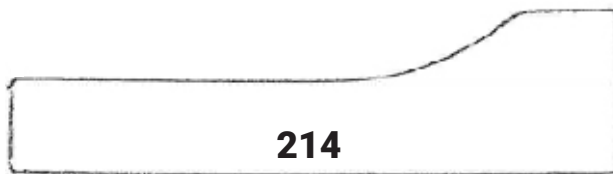

214
 $7/8" \times 3 1/8"$



215
 $1 1/8" \times 5"$

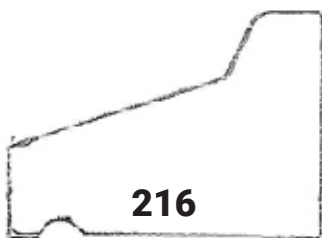

216
 $1 1/8" \times 1 5/8"$



217
 $1 1/2" \times 2"$

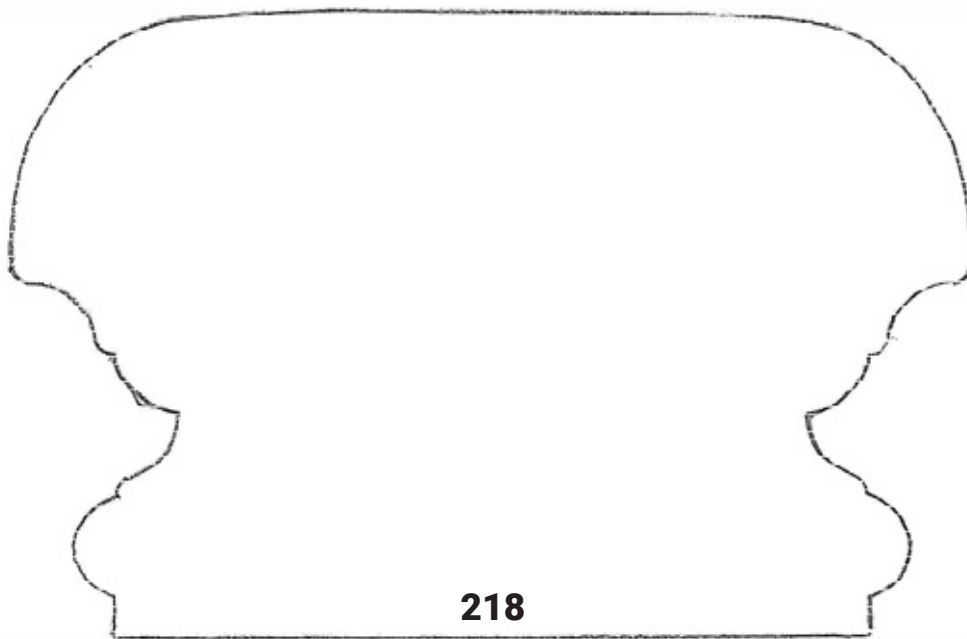

218
 $3 1/4" \times 5"$

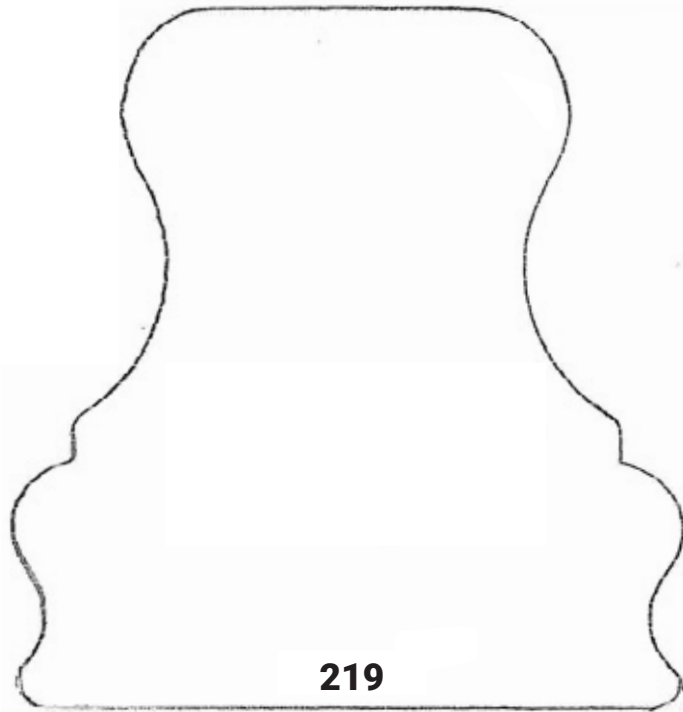

219

$3 \frac{5}{8}'' \times 3 \frac{1}{2}''$

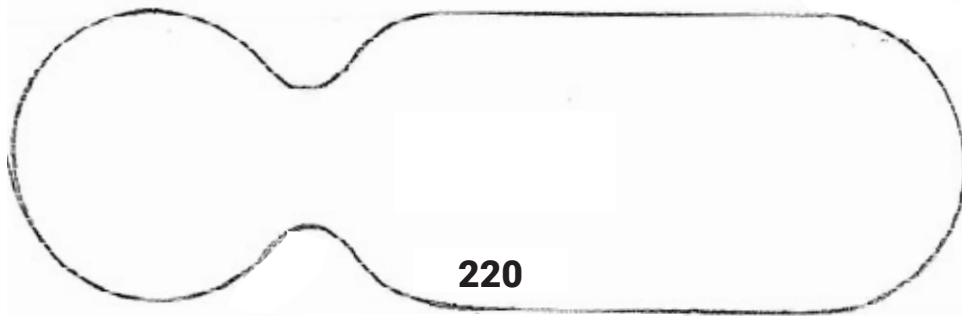

220

$1 \frac{1}{2}'' \times 5''$

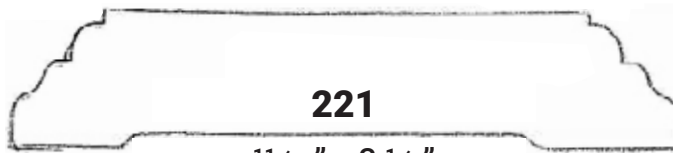

221

$1 \frac{1}{16}'' \times 3 \frac{1}{2}''$



222

$\frac{5}{8}'' \times 4 \frac{1}{4}''$

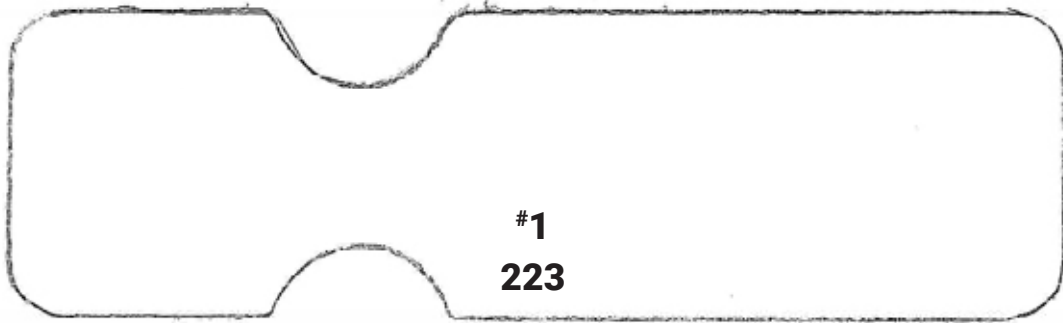

#1
223

1 5/8" x 5 1/2"

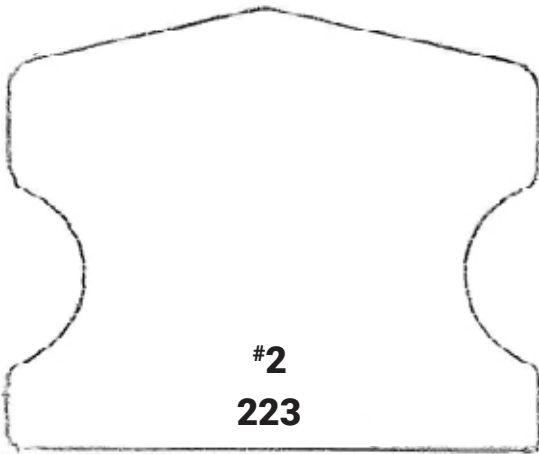

#2
223

2 1/4" x 2 3/4"

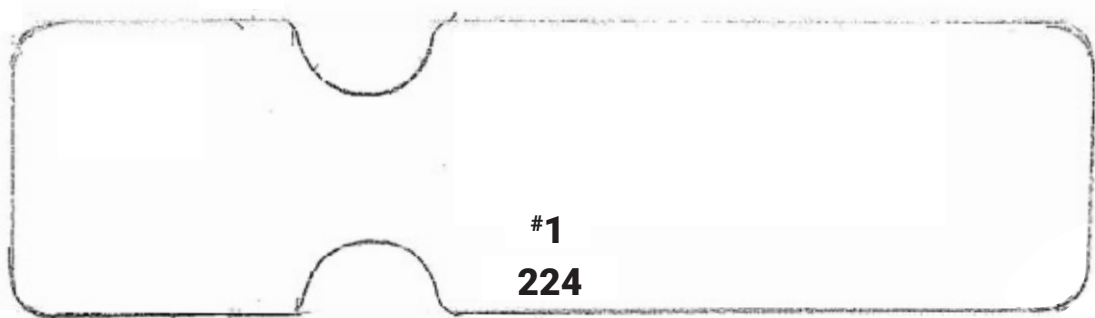

#1
224

1 1/2" x 5 1/2"

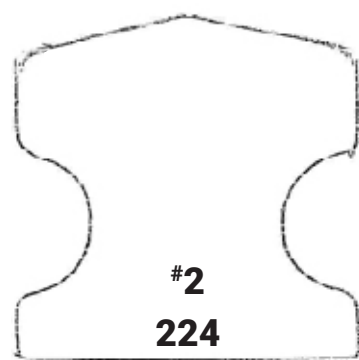

#2
224

1 3/4" x 1 3/4"

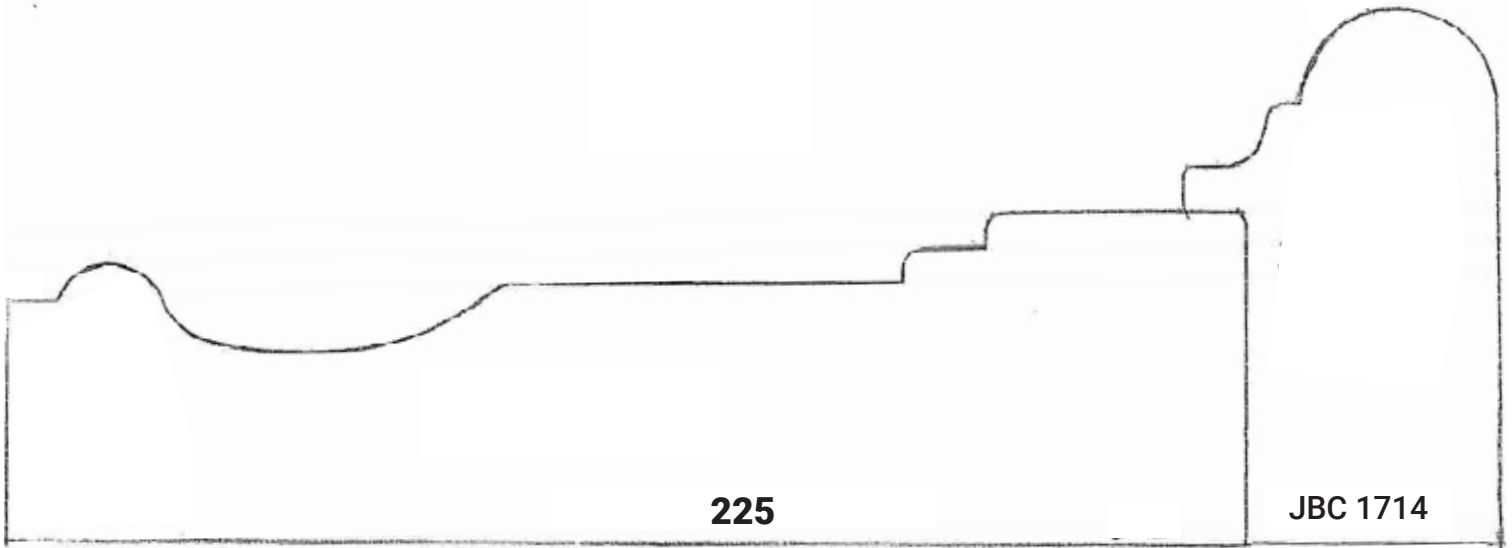

225

JBC 1714

$1\frac{3}{4}'' \times 6\frac{1}{2}''$



226

$\frac{3}{4}'' \times 5''$

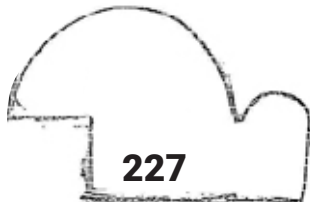

227

$1'' \times 1\frac{1}{2}''$

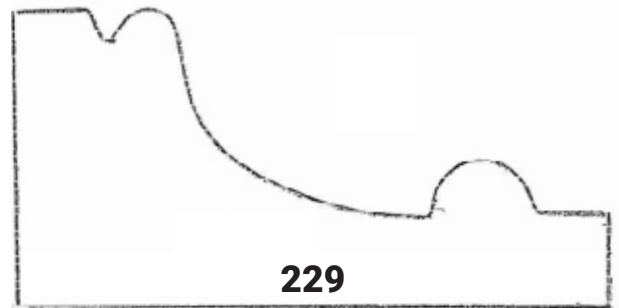

229

$1\frac{1}{2}'' \times 3\frac{1}{8}''$



228

$1\frac{3}{8}'' \times 1\frac{1}{2}''$

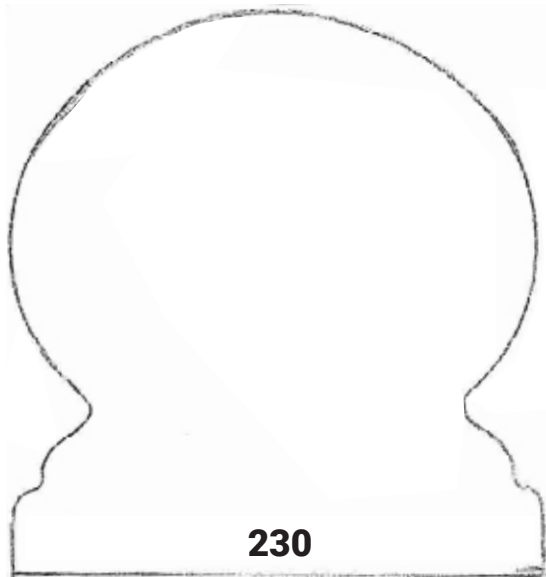

230

3" X 2 3/4"

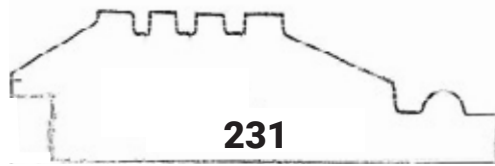

231

3/4" X 2 1/2"

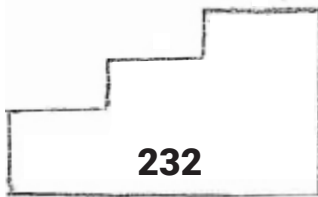

232

1" X 1 5/8"

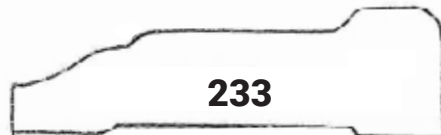

233

1 1/16" X 2 1/4"

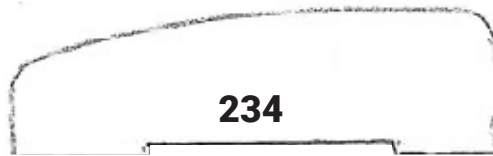

234

3/4" X 2 1/2"

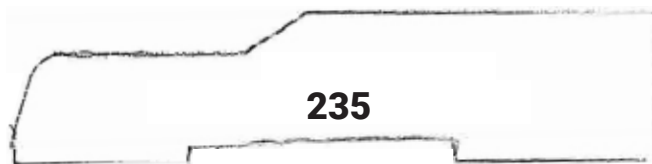

235

3/4" X 2 3/8"

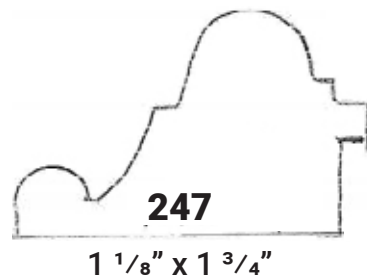
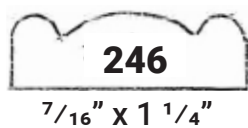
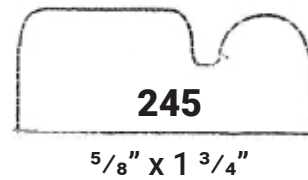
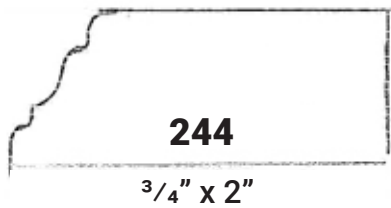
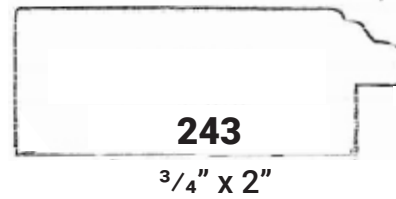
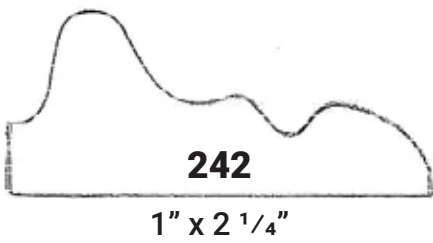
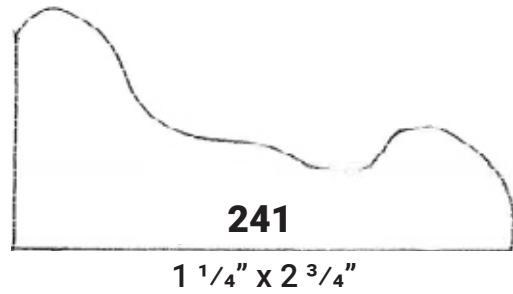
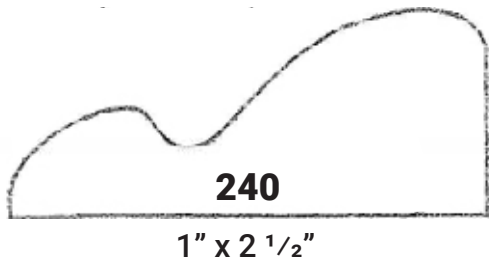
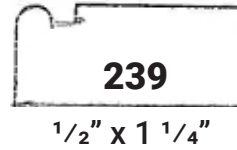
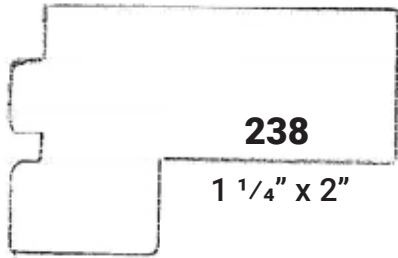
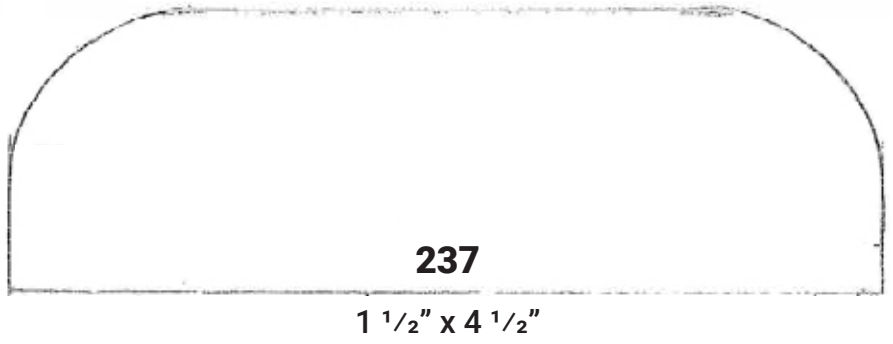
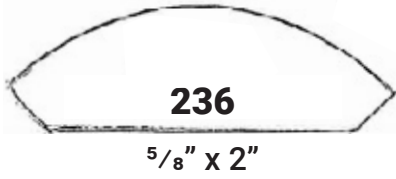



248

$\frac{3}{4}'' \times 2 \frac{1}{2}''$



249

$1'' \times 1 \frac{1}{4}''$



250

$\frac{3}{4}'' \times 2 \frac{1}{2}''$



251

$\frac{9}{16}'' \times 2 \frac{1}{4}''$



252

$\frac{1}{2}'' \times 1 \frac{5}{8}''$

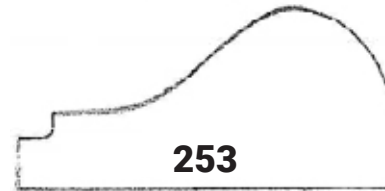

253

$1'' \times 2''$



254

$\frac{3}{4}'' \times 1 \frac{1}{2}''$



255

$\frac{11}{16}'' \times \frac{7}{8}''$

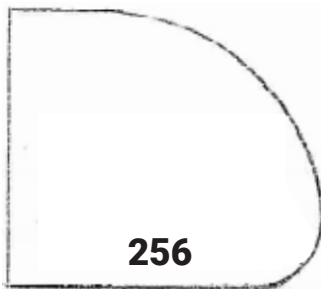

256

$1 \frac{1}{2}'' \times 1 \frac{5}{8}''$

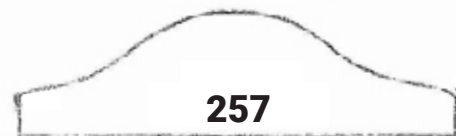

257

$\frac{5}{8}'' \times 2 \frac{1}{4}''$

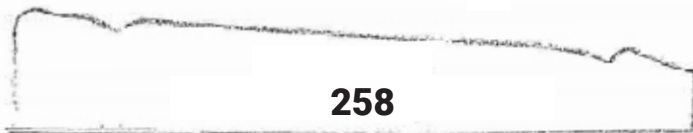

258

$\frac{5}{8}'' \times 3 \frac{1}{2}''$

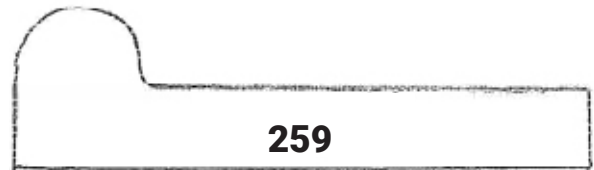

259

$\frac{13}{16}'' \times 3''$



260

$\frac{9}{16}'' \times 1 \frac{1}{2}''$

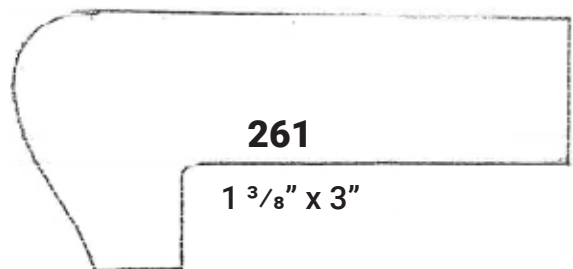

261

$1 \frac{3}{8}'' \times 3''$

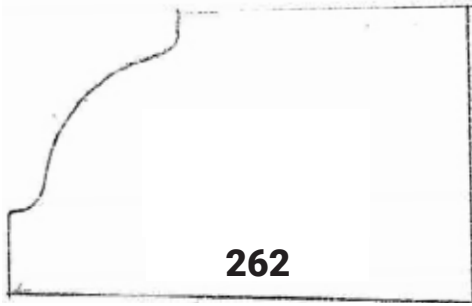

262

1 1/2" X 2 1/2"



263

1 1/8" X 2"

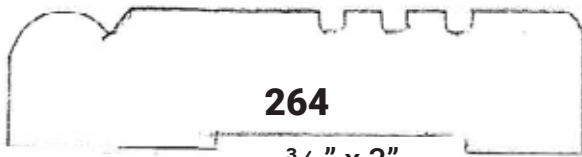

264

3/4" X 3"

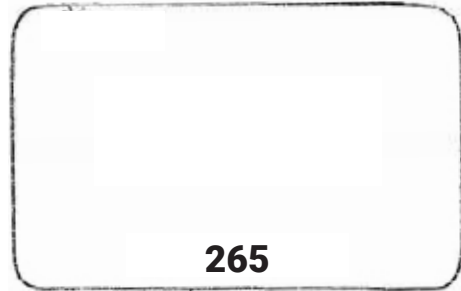

265

1 1/16" X 1 1/2"



266

7/16" X 1 1/4"



267

3/4" X 3"



268

7/16" X

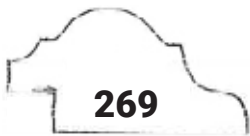

269

5/8" X 1 1/4"



270

3/4" X 1 3/8"

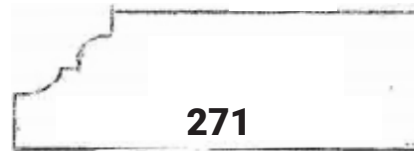

271

3/4" X ?

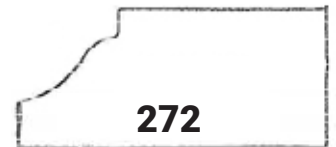

272

3/4" X ?



273

5/8" X 3/4"

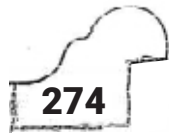

274

5/8" X 3/4"



276

1 1/16" X 2 1/4"

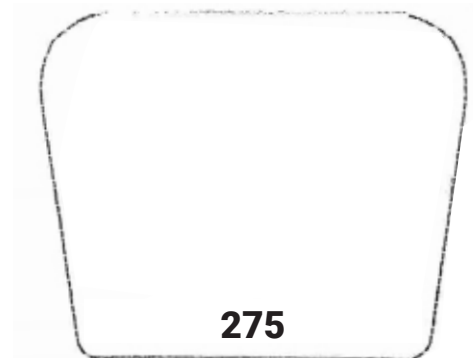

275

1 3/4" X 2 1/4"

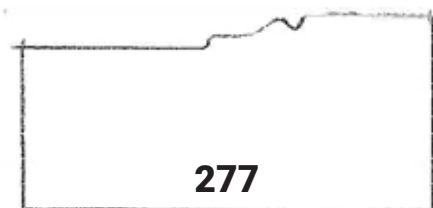

277
1" x 2 1/8"

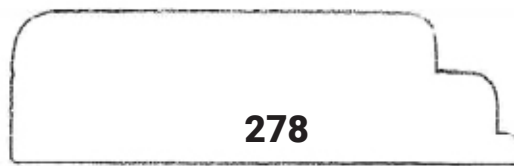

278
3/4" x 2 3/4"

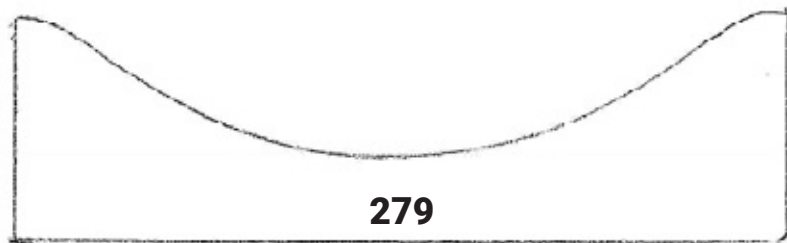

279
1 1/8" x 4"

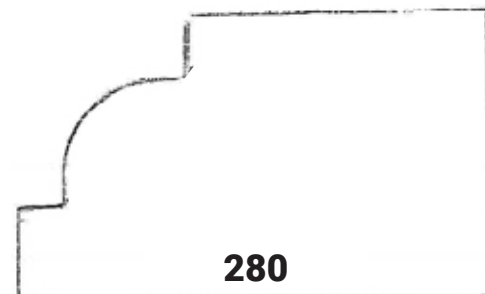

280
1 1/2" x 2 1/2"



282
3/4" x 5 1/2"



283
1 1/16" x 1 1/2"

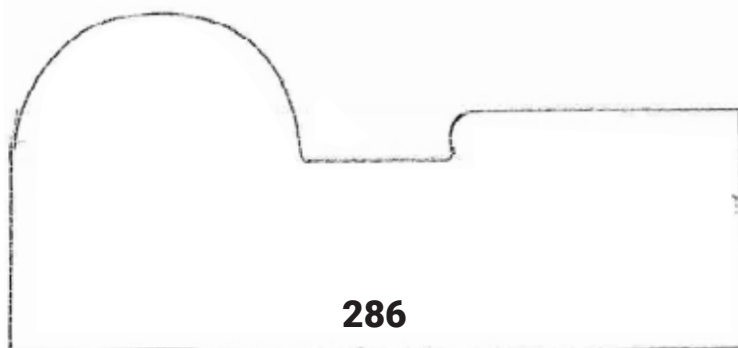

286
1 3/4" x 4"



284
3/4" x 2 3/8"

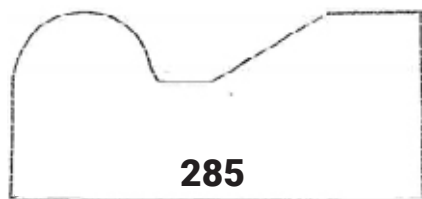

285
1" x 2 1/4"



287
1 1/8" x 4"



288

$\frac{9}{16}$ " X $1\frac{7}{8}$ "



289

$\frac{3}{4}$ " X 4"

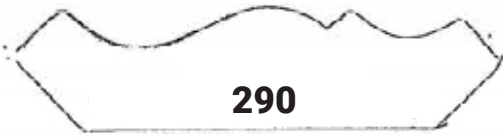

290

$\frac{3}{4}$ " X $2\frac{1}{2}$ "

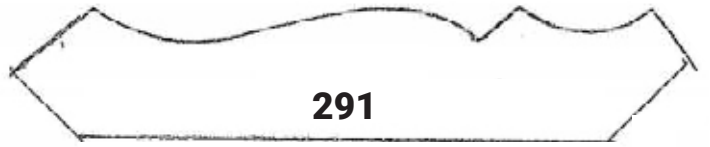

291

$\frac{3}{4}$ " X $3\frac{1}{2}$ "

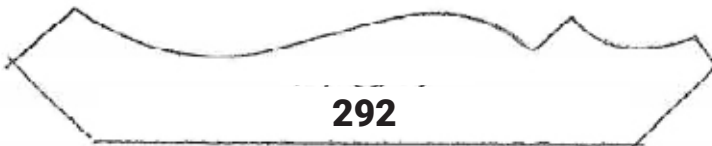

292

$\frac{3}{4}$ " X $3\frac{5}{8}$ "



293

$\frac{1}{2}$ " X $1\frac{1}{4}$ "

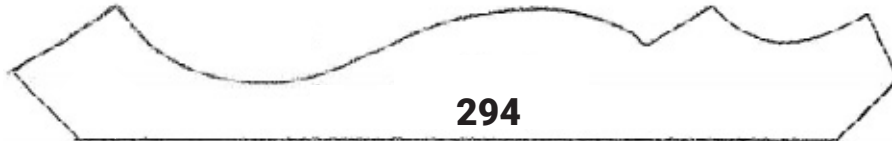

294

$1\frac{1}{16}$ " X $4\frac{5}{8}$ "

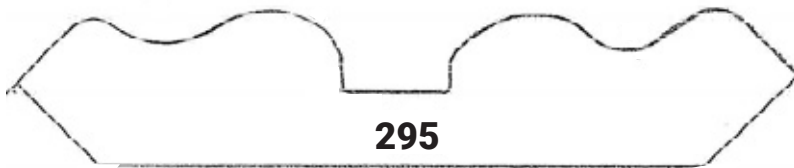

295

$\frac{3}{4}$ " X 4"

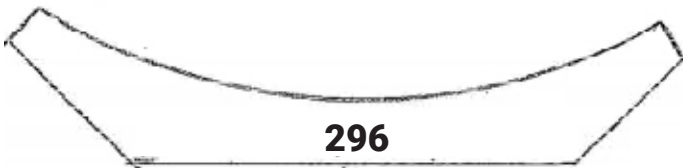

296

$\frac{3}{4}$ " X $3\frac{1}{2}$ "



297

$\frac{3}{4}$ " X 3"

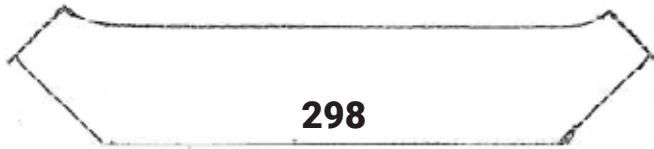

298

$1\frac{1}{16}'' \times 3\frac{1}{4}''$



299

$1\frac{1}{16}'' \times 2\frac{1}{4}''$

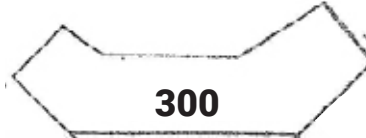

300

$1\frac{1}{16}'' \times 1\frac{7}{8}''$



301

$1\frac{3}{16}'' \times 2\frac{3}{4}''$

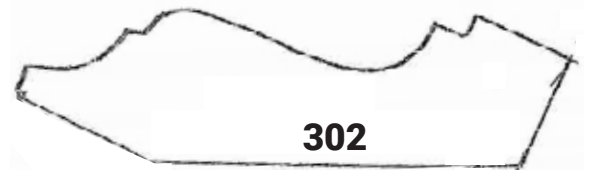

302

$1\frac{3}{16}'' \times 2\frac{7}{8}''$



303

$\frac{3}{4}'' \times 3\frac{3}{4}''$

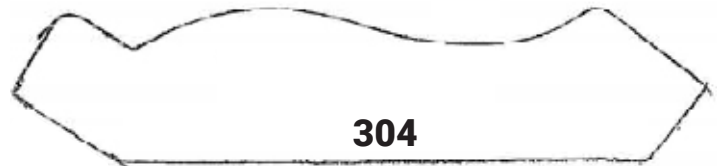

304

$\frac{3}{4}'' \times 3\frac{5}{8}''$

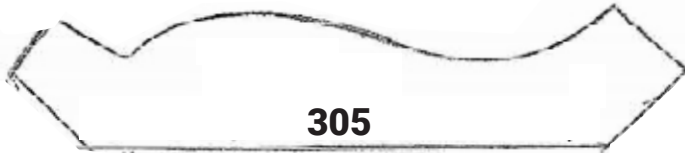

305

$\frac{3}{4}'' \times 3\frac{1}{2}''$

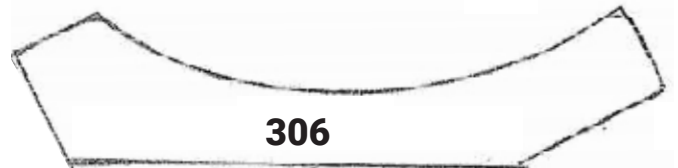

306

$\frac{3}{4}'' \times 3\frac{3}{8}''$

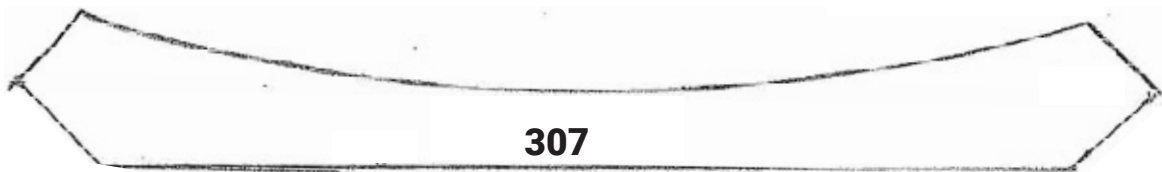

307

$\frac{3}{4}'' \times 6''$

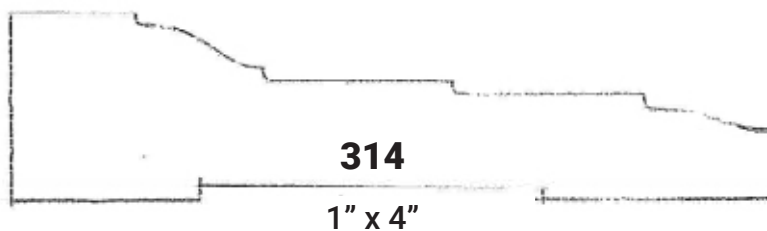
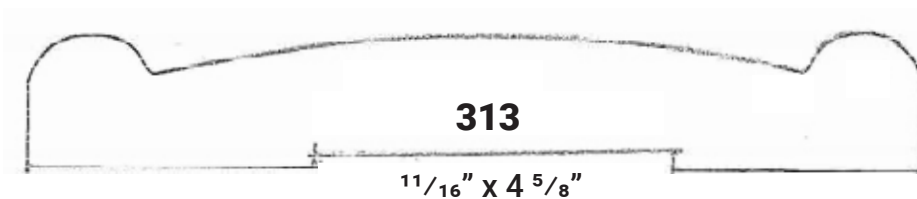
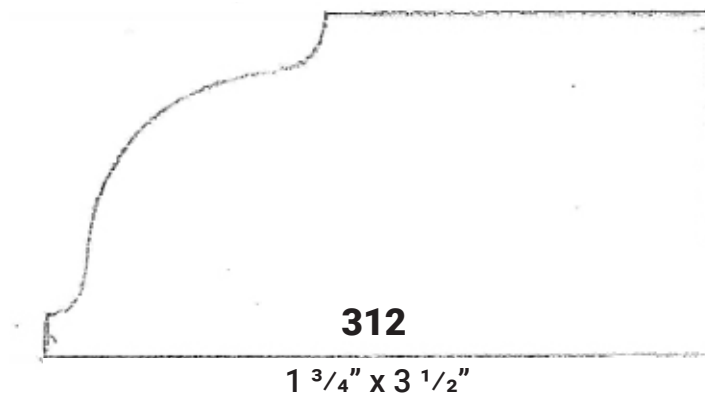
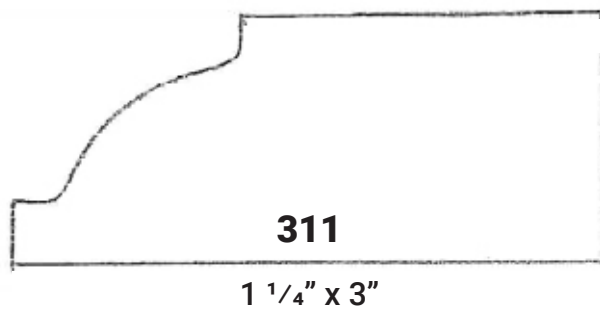
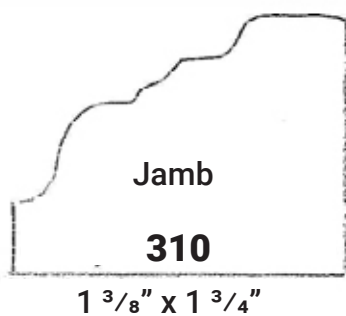
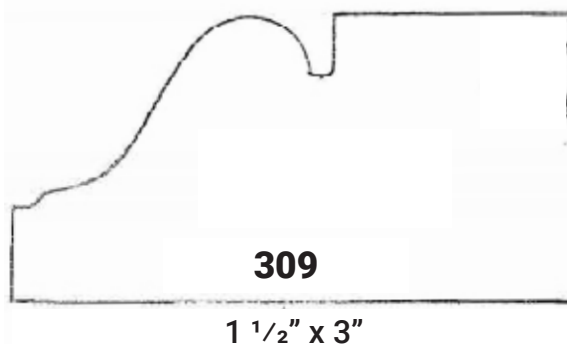
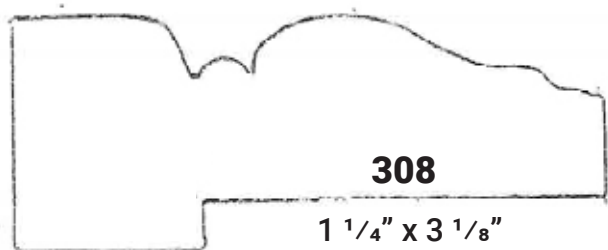

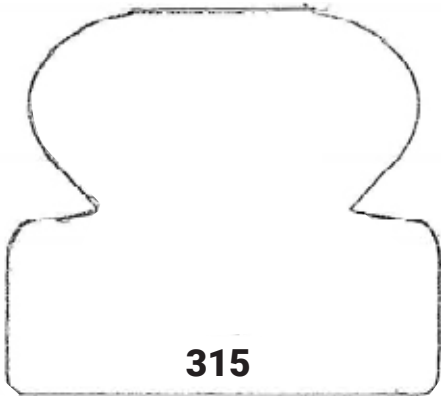

315

2" x 2 1/4"

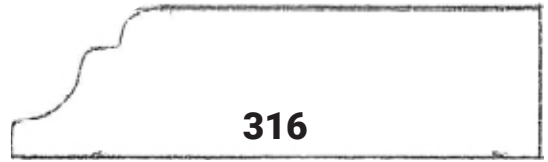

316

3/4" x 2 3/4"

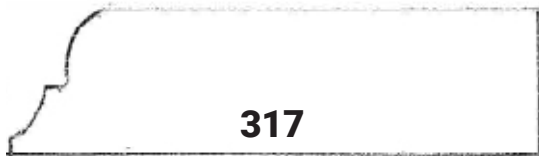

317

3/4" x 2 3/4"



318

3/4" x 2 1/2"

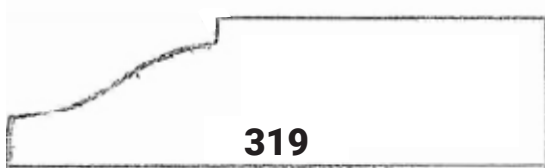

319

3/4" x 2 3/4"

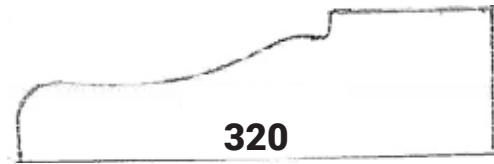

320

3/4" x 2 1/2"



321

1 5/8" x 3 1/8"

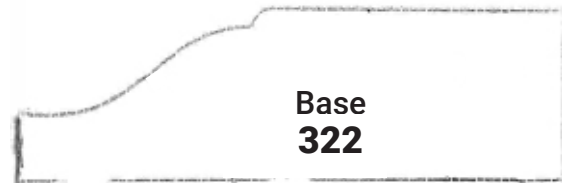

Base
322

3/4" x ?"



323

1 1/2" x 1 1/2"

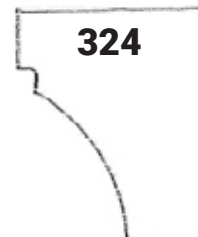

324

1 1/4" x 1"

